

Research Paper

Beyond the Real Methods of Re-presenting Reality in Iranian Gardens

Negar Maleki Sadeghi, S. Yahya Islami*

School of Architecture, College of Fine Art, University of Tehran, Iran

Received: July 2022, **Revised:** December 2023, **Accepted:** December 2023, **Publish Online:** December 2023

Abstract

Architecture, akin to other forms of art, often transcends mere functional considerations, striving to re-present reality in a manner that engages the senses and shapes the human psyche. The Iranian Garden, also known as the Persian Garden, holds a distinctive status in Iranian spatial and environmental design. Its meticulously balanced and structured amalgamation of natural and man-made elements has transformed the Iranian Garden into a global phenomenon, offering a uniquely nuanced portrayal of the world. This investigation delves into three specific Iranian gardens, aiming to elucidate how reality is re-presented within Iranian garden design to attain a transcendent experience. Utilizing a qualitative and interpretive analysis of contemporary theories addressing issues related to image and reality, this paper initially introduces three categories for representing reality—intensification, integration, and transformation—alongside two realms of experience: the corporeal and the mental. These modes of depicting and experiencing reality are subsequently explored within the context of three renowned Iranian gardens—Dolatabad Garden of Yazd, Fin Garden of Kashan, and Shazdeh Mahan Garden of Kerman. This examination serves to illustrate the diverse design solutions employed to re-present familiar reality to observers. The evaluation of these gardens involved on-site visits, personal immersion in the garden environments, and a reliance on existing documentation and theories regarding these spaces. The findings of this study reveal a sophisticated and adept utilization of architectural and spatial components in garden design. Through varied approaches to re-presenting familiar reality, these gardens craft an aesthetic experience that stimulates the senses and elevates both the intellect and the spirit. Such interpretations of the traditional Iranian Garden offer valuable insights for designers seeking to emulate the spatial qualities without resorting to the replication of familiar motifs and forms. It is anticipated that a deeper comprehension of how the Iranian Garden re-presents the familiar will guide future endeavors to adapt it for contemporary times, steering clear of deviations that might compromise its essential nature.

Keywords: Representation, Reality, Design Theory, Architecture, Iranian Garden.

1. INTRODUCTION

Art plays an elemental and primal role in the annals of human history. It is through art that the world unfolds itself to humanity, offering an avenue to perceive and experience the world differently (Dawey & Malpas, 2016, p. 60). According to Hans-Georg Gadamer, our connections with works of art, akin to significant life experiences, are profound and immediate. Gadamer posits that art can be likened to a form of play, a collaborative engagement where the artist and the audience converge (Gadamer, 1986). In

this context, architecture, as a manifestation of art, has the capacity to beckon us towards an alternative experience of the world and a distinct comprehension of reality.

Each architectural creation has the potential to mold a distinctive reality for its audience by interpreting familiar elements and influencing the perceptions of the visitor's body and mind. Representation emerges as a pivotal tool in artistic expression, where the artist isolates and selects facets of reality, imprinting their unique vision upon our world and thereby crafting a new realm (Hursthouse,

* Corresponding author: y.islami@ut.ac.ir

1992, p. 276). Art, as Graham notes, assumes the special responsibility of captivating the aesthetic disposition by generating representations of entities (Graham, 2006, p. 22). Consequently, the representation of reality in art engenders a fresh understanding of reality.

Architecture, in line with other art forms, employs its distinct language and tools to encapsulate reality. The Iranian Garden, also recognized as the Persian Garden, occupies a distinctive niche in Iranian spatial design. It transcends being merely a memorable locale, distinguishing itself from indifferent spaces by serving as an ecosystem intertwining natural and man-made phenomena that harmonize to create a delightful yet surreal encounter. Within an Iranian Garden, one finds oneself simultaneously detached from and reintroduced to reality. As Nader Ardalan notes, although the Iranian Garden induces a profound sense of place and presents a comprehensive reflection of the world (1973), this reflection is not a mere representation but rather a re-presentation, functioning on various levels. This study seeks to unveil the techniques, both simple and sophisticated, employed to achieve this nuanced re-presentation

2. ART AND THE RE-PRESENTATION OF REALITY

Any worldview is grounded in assumptions regarding the fundamental nature of "reality"—whether an absolute, objective reality exists independently of the observer, or if the facts of reality are relative to a particular observer. Sir Isaac Newton, for instance, selected space and time as the absolutes for his theories. In his framework, space and time were conceived as dimensions of an independent container, forming the basis for an "objective" description of an object or event, unaffected by the objects contained within (Flach, 1998).

The term "reality" is multifaceted, generally denoting the observable world that can be understood. In architecture, the concept of reality encompasses everything, irrespective of whether it is created, designed, observable, or comprehensible. In this context, reality may encompass terms such as void, space, building, built, dynamic, and stable (Schnabel & Wang, 2009). Architecture, in the absence of formal instruction and literature, becomes a key to understanding reality, serving an educational purpose through the designed environment (Tuan, 2001, p. 102). In certain societies, a building serves as the primary text, presenting a specific viewpoint of reality (Tuan, 2001, p. 112). The reality we can know is a construct derived from experience, shaped by emotion

and thought (Tuan, 2001, p. 9). Therefore, discussions about the concept of reality in space encompass both the experience of reality and its empirical perception, acknowledging that our perception is influenced by the quality of the experience.

Experience serves as an overarching term encapsulating the diverse modes through which an individual comprehends and constructs reality. These modes range from the more direct and passive senses of smell, taste, and touch to the active sense of visual perception and the indirect mode of symbolization (Tuan, 2001, p. 8). An object or place achieves concrete reality when our experience of it is comprehensive, involving all the senses as well as an active and reflective mind (Tuan, 2001, p. 18). According to Hermann von Helmholtz, the biological and sensory mechanisms form the foundation for objectively defining the stimuli of experience. The structure of nerves, eyes, corners, muscles, brain, etc., serves as the cornerstone for understanding the experience of reality (Helmholtz, 1962).

For Gibson, the essence of experience is firmly rooted in action. This perspective posits that the perception of space relies more on the mode of locomotion than on visual and acoustic images. The tangible reality of a surface is gauged by its implications for action, such as whether it impedes locomotion, rather than its appearance, such as resembling a wall (Flach, 1998). Dewey's viewpoint aligns with a functionalist approach, emphasizing the role of action and the purposes behind it in defining the stimuli of experience. Here, the reality of experience is intricately linked to the intentions and action capabilities of the "actor" (Dawey & Malpas, 2016).

Maurice Merleau-Ponty contributes a perspective that underscores the body as our primary tool for "having the world" and engaging constantly with it (Hale, 2017). According to Merleau-Ponty, sensory perception, as an activity involving the entire body, forms the core of our experience and understanding of the world (Ibid). Therefore, the body, followed by sensory perceptions as the receptors of environmental information, and the brain and mind as processors of information, collectively play pivotal roles in the experience and perception of reality.

The experience of any place transcends mere physical sensations, encompassing mental dimensions as well. Consequently, an examination of various theories concerning the experience of reality suggests that space and time can be regarded as two defining characteristics of reality experienced actively through both the body and the mind.

In this context, art transcends reality, portraying it as something beyond the familiar or the everyday. Art

serves as an artist's distinctive expression of reality. Schiller perceived the freedom inherent in artistic creativity not merely as a way of relating to the world but as a means of perfecting the world by transcending its mundane qualities. Consequently, Schiller positions art as something superior to reality (Kidder, Gadamer for architects, 2013). Gadamer, on the other hand, views art not only as secondary to reality but also as an augmentation of the reality it represents (Dawey & Malpas, 2016). As Kidder notes, "A work of art is not just a record of something as it is; rather, it is always an increase in being" (Kidder, 2013, p. 23). Art shapes, orders, and highlights features of its subject, presenting it to us in a particular light (Kidder, 2013, p. 23). Representation, understood as the relationship between a work of art and something real external to it, is a crucial aspect of visual art that enhances our understanding of life (Hursthouse, 1992). Representation, according to Graham, is a means and not an end in art (Graham, 2006, p. 126).

Art and architecture signify an augmentation of "being," revealing the "lighting" that transforms the world of things into objects and the event of becoming-into-being. The representative power of art and architecture, distinct from replacement, substitution, or copy, sets them apart from other technological achievements (Gómez, 2006, p. 22). According to Nelson Goodman, a building, more than most works, physically alters our environment, and as a work of art, it can inform and reorganize our entire experience through various avenues of meaning. Similar to other works of art and scientific theories, buildings can both represent and exemplify (Graham, 2006, p. 180).

3. Three Methods of Re-Presenting Reality

Through an exploration of diverse theories elucidating the essence of reality and its portrayal across various mediums, three distinct methods of re-presenting reality can be identified. These methods include: 1. Intensification of reality 2. Integration of realities 3. Each of these methods encompasses its own variations and subcategories, offering a nuanced approach to re-presenting reality. The implementation of these methods can take on numerous forms, providing a rich array of techniques and strategies (refer to Table 1).

3.1. Intensification

What defines a work of art is the intensification of being (Gómez, 2006, p. 24). In a work of art, we encounter ourselves, our emotions, and our own being in the world in an intensified manner (Pallasmaa,

2009, p. 63). Architecture, as an art form, similarly aims to intensify being. The power of architecture lies in its capacity to enhance the experience of the real (Pallasmaa, 2014). Rudolf Arnheim describes potent architectural images, such as the radiance of a cathedral window, as a form of intensification akin to the morning light streaming through it (Mallgrave, 2011).

Objects, in fact, present themselves to us in a Gestalt form, as structured wholes where their properties strongly relate to each other. Consequently, each property reinforces the others (Hale, 2017). A remarkable building enriches and articulates our comprehension of gravity, materiality, horizontality, verticality, and the enduring mysteries of existence, such as light and silence (Pallasmaa, 2009, p. 66). Moreover, the focal point of architecture should be on enhancing the perspective of the experiencing individual and emphasizing the significance of being mindfully present in space (Bohme, 2013).

Architecture intensifies the reality of space when it makes the physical and perceptual experience of space more tangible. Thus, intensification is the process by which the experience of reality becomes more impactful through architecture. This intensification of reality through architecture is a situation in which the spectator and inhabitant experience everything in an intensified manner. In this mode of re-presentation, the original nature of reality is preserved, but different components of reality are highlighted and strengthened, rendering them more tangible and memorable. When an architect employs certain architectural components to focus on a specific sense or aspect of architecture, an intensified experience ensues.

3.2. Integration

Maurice Merleau-Ponty introduced the concept of an "in-between" reality or ground that serves as a universal platform for bringing things together. Enmeshed experience transcends being a mere location for events, objects, and activities; it is a more intangible realm arising from the continuous unfolding of overlapping spaces, materials, and details (Holl, 2006, p. 45). In this overlapping, diverse concepts and expressions of reality converge into a unified whole.

Merleau-Ponty's "in-between" reality can be likened to the moment when objects blend with the field. The architectural synthesis of foreground, middle ground, and distant views, coupled with subjective qualities of material and light, lays the foundation for "complete perception." Works or objects of art that evoke emotions are multifaceted;

they possess numerous, perhaps endless layers of meaning that overlap, interweave, and evolve with changes in our observation angle (Zumthor & Oberli-Turner, 1998).

This mode of experiencing reality can be defined as integration. In this method of representing reality, different manifestations of reality are presented together, merging and combining various layers. Integration showcases different facets of reality in a scene to construct a merged reality.

In architecture, transparency at times allows for reflection and fusion, intertwining surface and depth to create simultaneous and enmeshed images (Pallasmaa, 2011, p. 81). Transparency facilitates the concurrent presence of layers of reality. While the distinct nature of each reality layer is discernible in the integration, the end result is a new and combined reality obtained from the integration of these layers. Another example of integration in architecture involves distinguishing between background and foreground and crafting depth in a specific point of view.

3.3. Transformation

The transformation of reality finds its most conspicuous manifestation in simulation. Baudrillard's theory of representation delves into a realm of deception and transformation in reality, distinguishing between dissimulation and simulation. Dissimulation involves pretending not to possess what one has, while simulation entails feigning to possess what one lacks, blurring the lines between presence and absence (Baudrillard, 1994, p. 6). Both cases can be viewed as transformative processes that, in some way, obscure the essence of reality. According to Baudrillard, simulation poses a threat to the distinction between the

true and the false, the real and the imaginary (Baudrillard, 1994, p. 6).

The transformation of reality can also be influenced by seduction and deception in the representation of reality. Seduction, in this context, involves the eclipse of a presence, producing a flickering, hypnotic mechanism that captivates attention, transcending concerns with meaning (Baudrillard, 1990, p. 85).

In works of art, a tension exists between what is revealed, what is concealed, and what is yet to be shown (Dawey & Malpas, 2016). From a representational perspective, art brings forth associations beyond itself, evoking specific meanings or realities. Thus, artists, whether consciously or unconsciously, shape our perception of reality through their representations, influencing us to think and see differently (Hursthouse, 1992). Architecture, too, contributes to replacing a seemingly meaningless reality with a theatrically or architecturally transformed reality, offering an illusion of meaning (Pallasmaa, 2011, p. 123).

Symbols and the symbolic play a role in the realm of simulation (Baudrillard, 1983). Symbols refer to reality but express it with illusion and irony. This allusive expression of reality, present in art and mass media, becomes a form of reality transformation. Reality can be articulated and organized within a metaphorical continuum, allowing objects to assume new implications and interpretive possibilities when viewed through different lenses (Puglisi, Byatt, & Saggio, 1999). The transformation of reality, as a symbolic form, conceals within it the principle of reality. Structurally or content-wise, the transformation generates a new reality open to interpretation. Despite its connection to reality, the transformed reality presents a fresh image, confounding the mind about the principles of reality and introducing a novel perspective.

Table 1. Three methods of re-presenting reality

Intensification	Intensification, highlighting and strengthening the elements of reality
Integration	Integration and unification of disparate layers and expression of reality, in such a way that each layer is discernible, but a new, unified reality is achieved.
Transformation	Transformation of reality into a new reality in a way that the original appearance of reality has been changed or it can be interpreted and considered as a symbolic form of reality.

4. THE IRANIAN GARDEN

The Iranian Garden, also known as the Persian Garden, has long flourished primarily in the Iranian plateau and neighboring regions influenced by its rich cultural heritage. In Iranian literature, this unique garden has been referred to by various names, including "Baghsara," "Pardis" or "Ferdows," and "Bustan" or "Bostan," each carrying meanings ranging from garden to paradise. The Avestan term *pairidaēza*, Old Persian **paridaida*, and Median **paridaiza*, signifying a walled garden, were later borrowed into Akkadian and eventually entered Ancient Greek as *παράδεισος* (*parádeisos*), leading to the Latin *paradīsus* and, subsequently, finding their way into European languages such as French, German, and English (The Oxford English Dictionary Vol. 7, 1913, p. 736).

The Persian Garden at Pasargadae is often considered the prototypical model for these gardens. It is believed that Cyrus the Great personally commissioned the construction of Pasargadae Garden, featuring distinctive arrangements of trees, buildings, and other elements. What set the Persian Garden apart was its transformation into not only an integral part of architecture but also the focal point of it. Subsequent generations of European and Asian monarchs, as well as garden enthusiasts, emulated the concept and design of these gardens.

Situated along the path of a stream or river, the Iranian Garden is enclosed by lofty walls and is distinguished by a central pavilion. Key features of this garden include geometric order, symmetry, and balance, shaping the relationship between nature and architecture and facilitating the flow of water through various pools and streams. This geometric harmony resonates in various art forms, including Iranian paintings and Persian carpets.

5. RESEARCH METHODOLOGY

The Iranian Garden, or Persian Garden, stands as a unique work of art in Iran, embodying distinctive innovations and conceptual intricacies within the bounds of tradition and archetypal concepts. Characterized by order, proportion, sanctity, and privacy, the Iranian Garden eschews futility, excess, and extravagance. This study seeks to revisit the Iranian Garden by dissecting the components that play a significant role in re-presenting reality. To achieve this, a categorization of different methods of re-presenting reality (intensification, integration, and transformation) is presented as a theoretical tool, offering enhanced insights into Iranian gardens.

Employing a descriptive-analytical methodology, the study explicates and interprets various design elements used in Iranian Gardens in relation to these three methods of representing reality. Drawing on the experiential aspect of being in the garden and referencing existing theoretical texts on the subject, the study re-examines and redefines various elements of the garden.

The selection of gardens for analysis considers two key factors. Firstly, the case studies must exemplify a typical Iranian garden with essential and characteristic components. Secondly, the chosen examples should span a broad historical period to encompass diverse design traditions. Consequently, three prominent Iranian gardens from distinct historical periods were chosen: Fin Gardens of Kashan from the Safavid era, Dowlatabad of Yazd from the Afshari period, and Prince Mahan of Kerman from the Qajar dynasty. Table 2 provides an introduction to the three gardens, specifying their respective time periods and locations within Iran.





6. METHOD OF RE-PRESENTING REALITY IN IRANIAN GARDENS

The findings reveal that the re-presentation of reality in Iranian gardens incorporates methods aimed at enriching the spatial experience within these captivating environments. The various techniques and strategies employed in these gardens can be categorized and are discussed below.

6.1. Contrast, Dynamism, and the Intensification of Reality

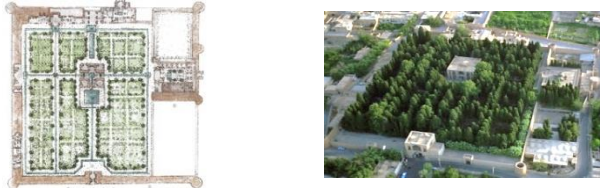
The intensification of reality in Iranian gardens is achieved through various means, encompassing the unity of diverse elements, the evocation of a desire for movement, the juxtaposition of contrasting elements, and the introduction of variety in the perception of space. Each of these factors contributes to enhancing, strengthening, or stimulating the distinctive characteristics of Iranian gardens. For instance, the intensification of reality through the unity of disparate elements becomes apparent in the way waterways and pools in the garden accentuate the interplay of light (Figure 1), or how the geometry in Karbandi structures intensifies the presence of light entering the building (Figure 2). Rhythm and repetition are additional tools employed to intensify the perception of form, space, and reality (Figure 3).

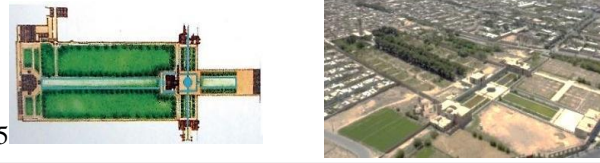
Table 2. Defining the case studies.

Garden and its historical period	Plan and aerial photos	Location
1- Fin Garden in Kashan (Alboryeh to Safavid era, 1628 A.D.)		
2- Dowlatabad Yazd (Late Afshari era- 1747 A.D.)		
3- Shazde Mahan (Qajar era-1897 A.D.)		

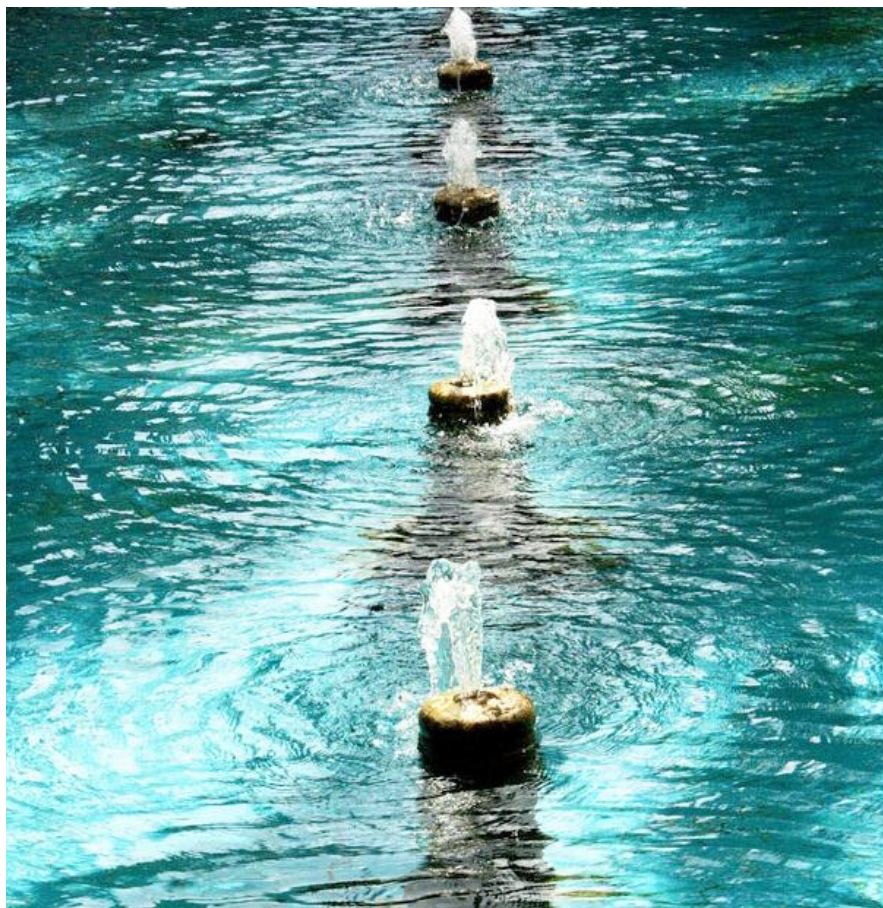

Fig 1. Compatible elements, light, and water, Fin Garden.

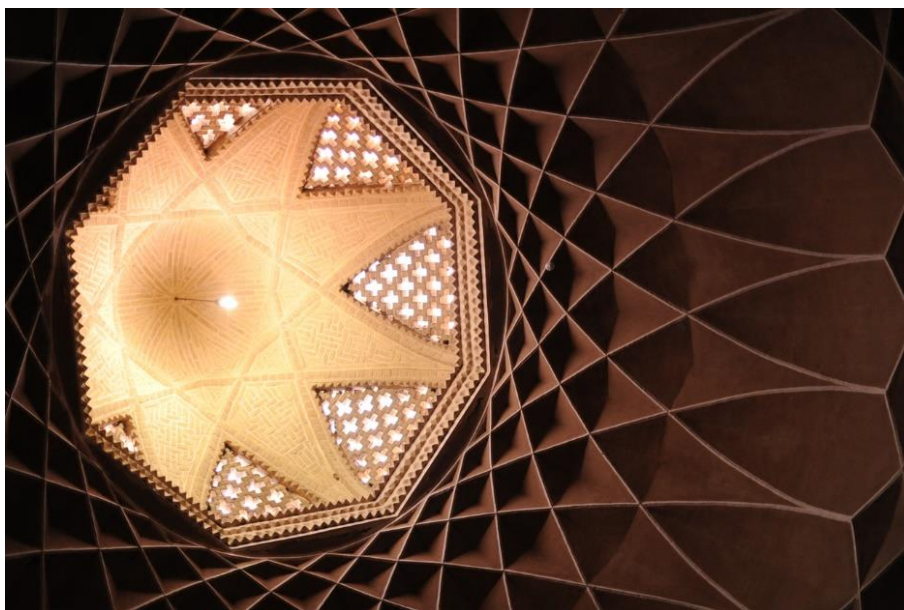

Fig 2. Compatible elements, light, and geometry, Dowlatabad Yazd Garden.



Fig 3. Rhythm and repetition to intensify the experience of space, Fin Garden.

Certain elements of the Iranian Garden actively encourage movement and foster an embodied experience of space, leading to an intensified perception of reality. For instance, the pavilions strategically positioned at the intersection of main axes and at the center of the garden are designed to facilitate the continuity of views, enticing visitors to traverse both the building and the entire garden

(Figure 4 & 5). This arrangement not only regulates the perception of space but also ensures a seamless and fluid experience. Additionally, a network of secondary axes beckons visitors to explore further throughout the garden (Figure 6). The embodied experience of space is further intensified by clearly defining spatial axes and incorporating stepped pathways that guide the body's movement through space (Figures 7 & 8).

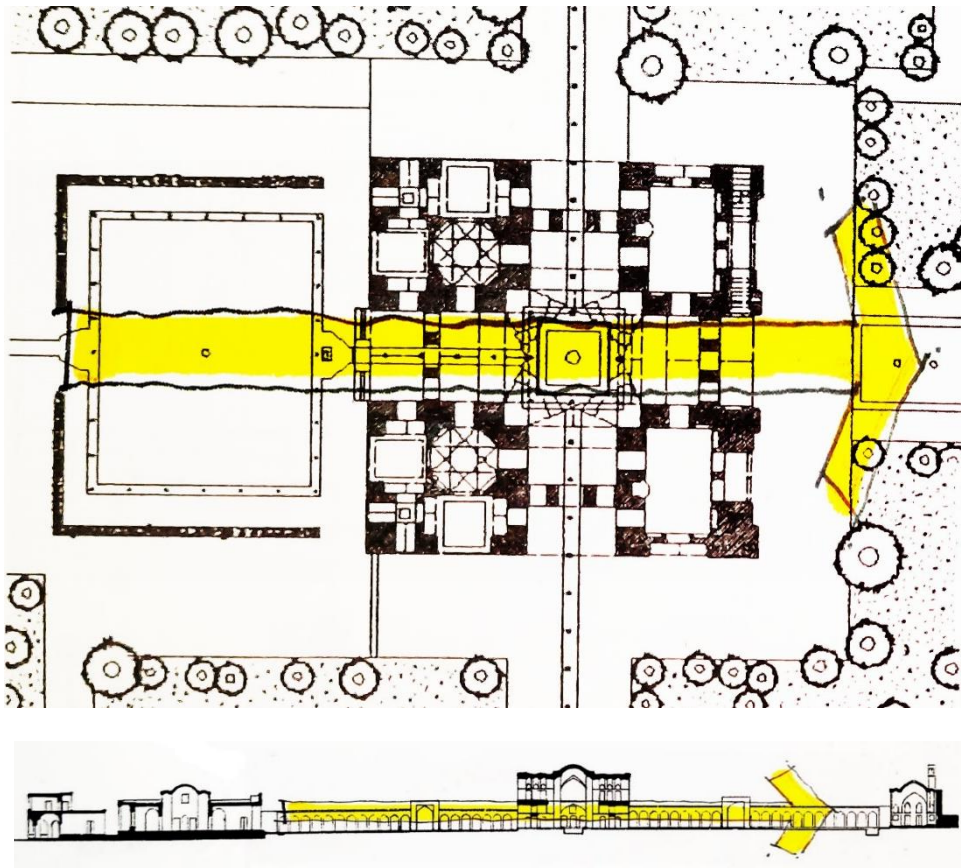

Fig 4. Extending the movement inside and beyond buildings, Fin Garden.



Fig 5. Conceptual transparency of space, Fin Garden.

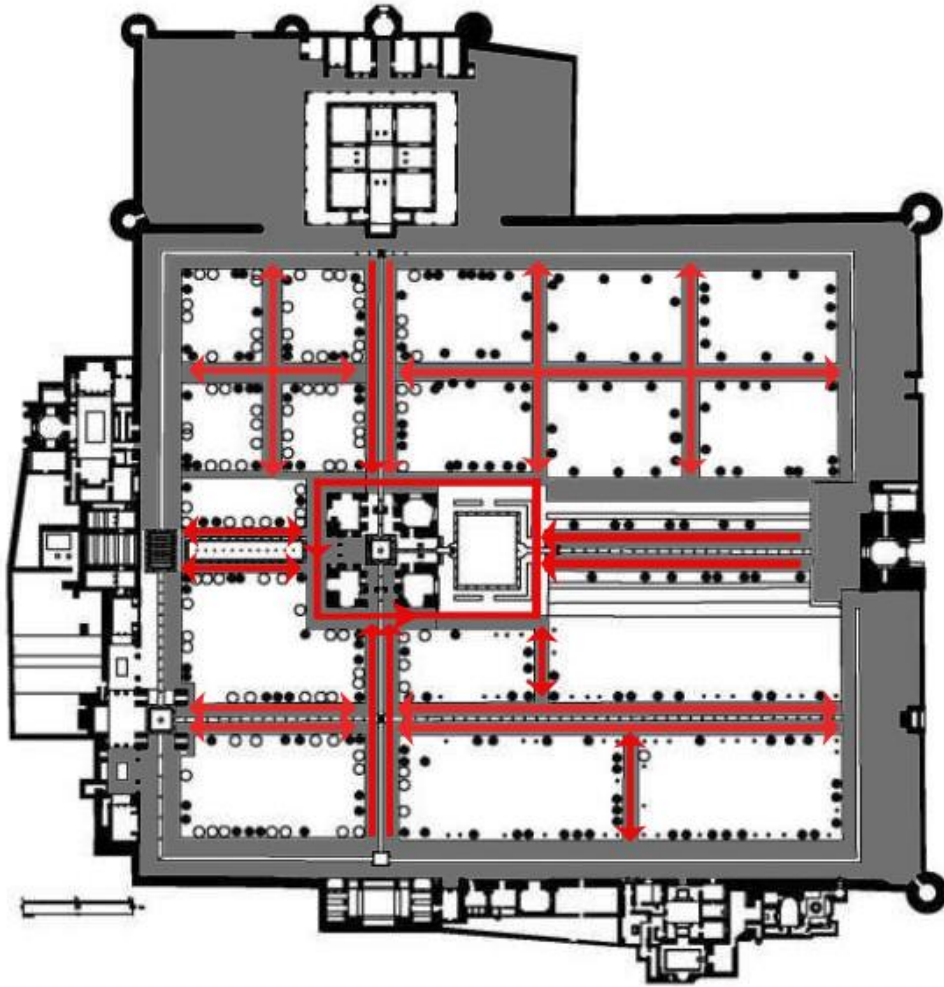

Fig 6. Network of axes, Fin Garden

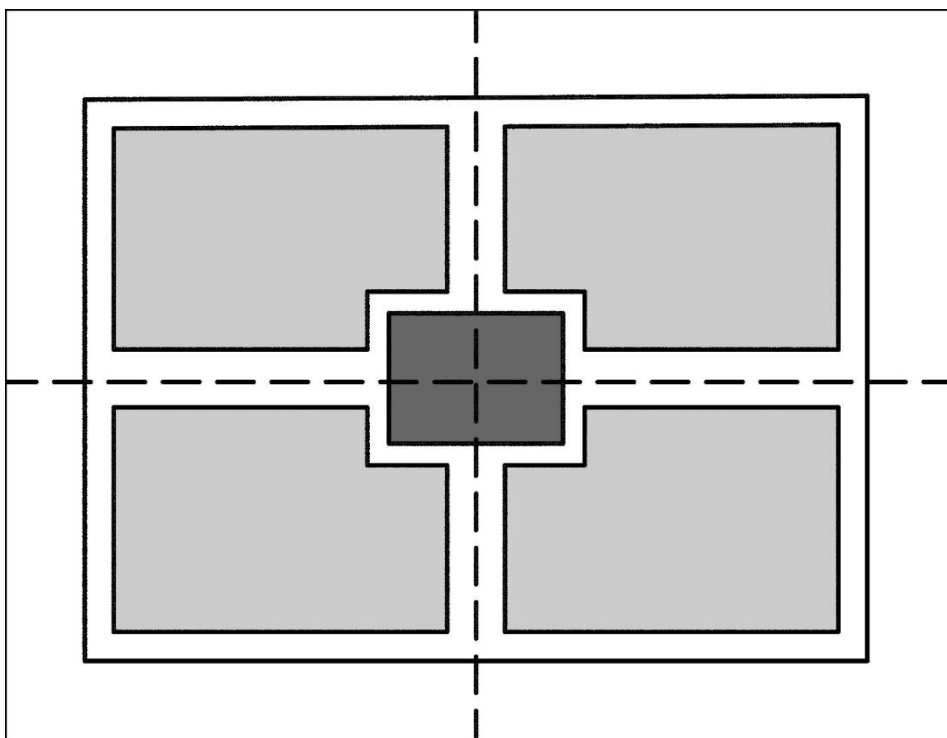

Fig 7. Strengthening the central forces

Contrast emerges as another technique employed to intensify the experience and comprehension of phenomena within the Iranian Garden. Notably, the interplay of contrast between motion and stillness, sound and silence, the vertical and the horizontal, as well as light and dark, simplicity and complexity,

stands out as prominent applications of this technique (Figures 9, 10, 11, and 12). The deliberate use of contrast contributes to a sense of variety in the perception of space within the Iranian Garden, engaging all human senses (Figures 13, 14, and 15).

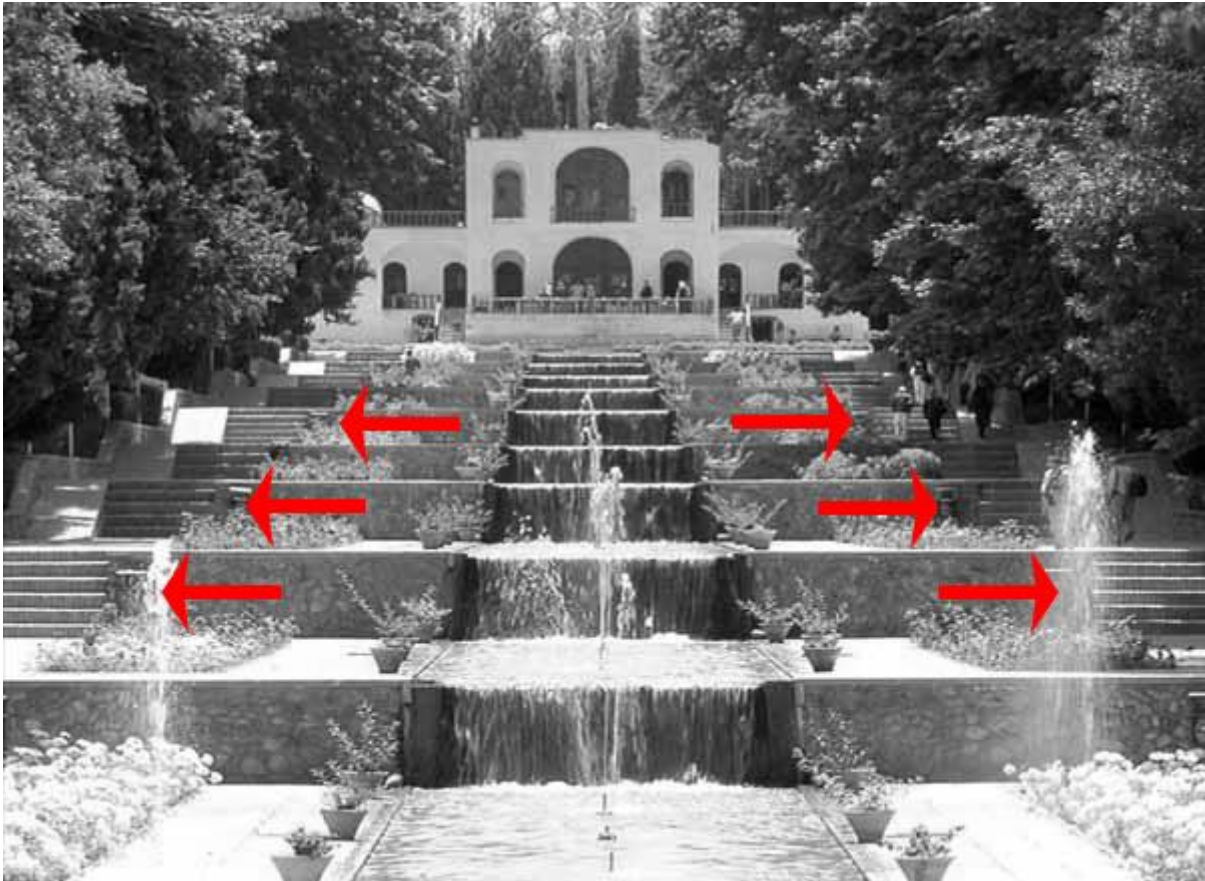

Fig 8. Utilizing the physical experience of reality by creating a stepped pathway, Shazdeh Mahan Garden.

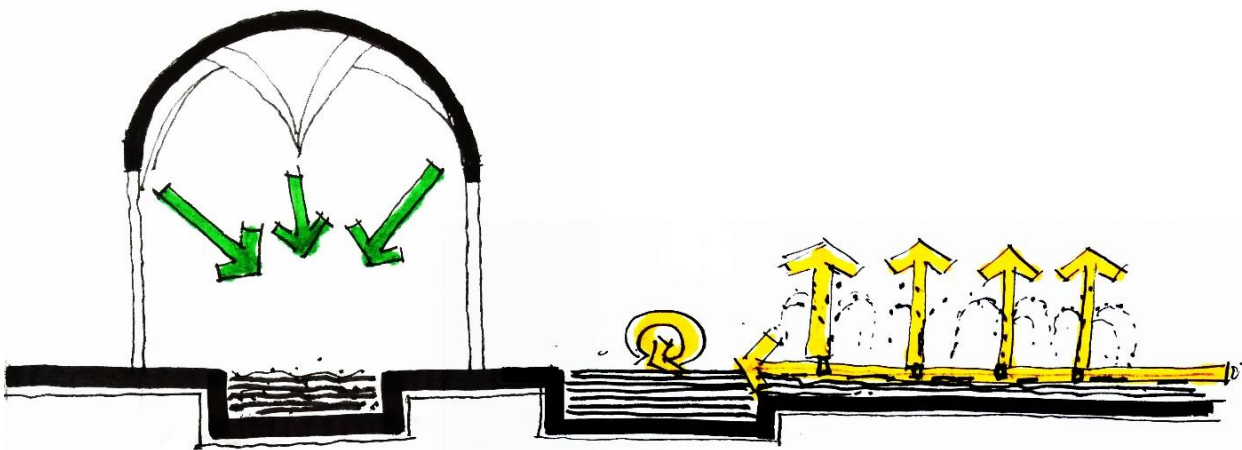

Fig 9. Contrast of motion and stillness and silence and sound

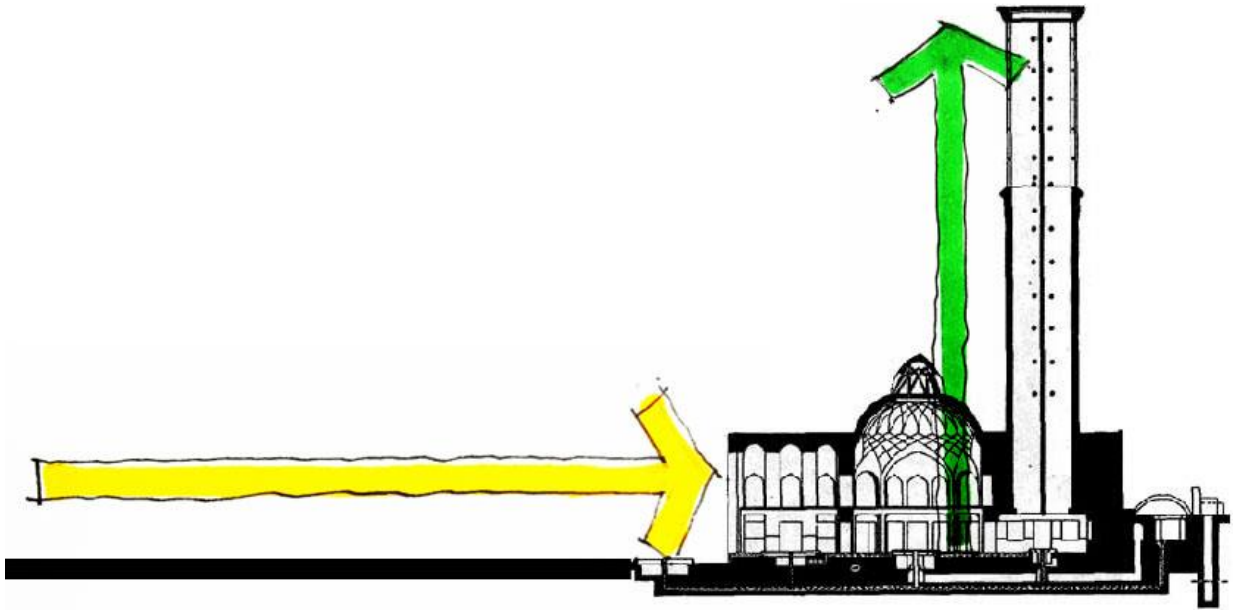

Fig 10. The contrast between vertical and horizontal forces, Dowlatabad Yazd Garden.



Fig 11. The contrast between darkness and light, Fin Garden.



Fig 12. The contrast between simplicity and complexity: patterned alongside plain elements, Fin Garden.

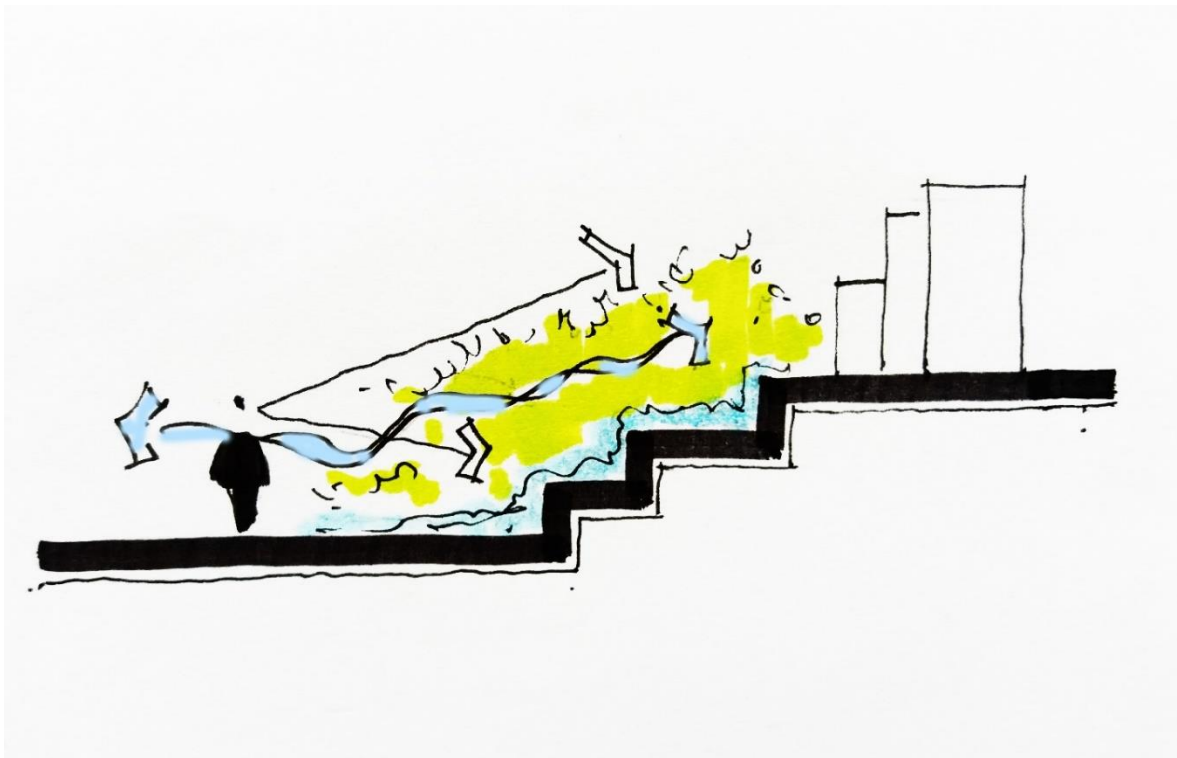

Fig 13. Stimulating all five senses

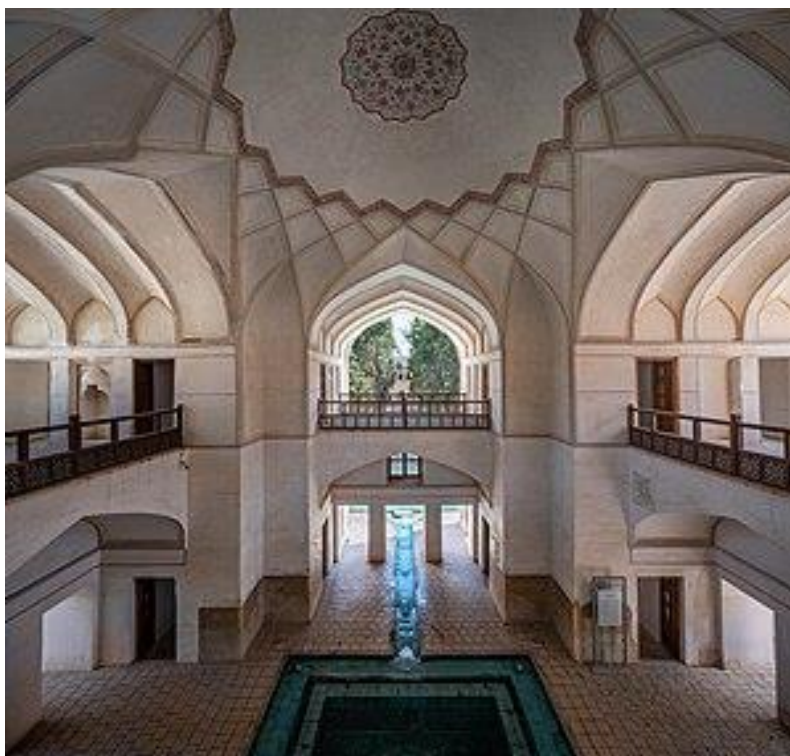

Fig 14. Creating different views of a specific reality, Fin Garden.



Fig 15. Immediate and gradual changes in visual sequences, Fin Garden.

6.2. Demarcation, Layering, and the Integration of Different Realities

In this particular strategy, the simultaneous presence and integration of different layers of reality shape the viewers' understanding of space and time. The case studies reveal that this occurs in two distinct ways: through the separation and integration of

different layers of reality, and through the separation and integration of reality and virtual reality.

In the architectural design of the Iranian Garden, the various layers of space fluidly interact with each other. Although demarcated and distinct, they are harmonized in a manner that produces an integrated reality. One method employed to achieve this is the transformation of 3D space into 2D space through

framing. This technique involves the unification of two layers of reality, the outside and inside of a building, to create a cohesive image (Figures 16 & 17).

Architectural features such as permeability and transparency facilitate the flow of spaces into each other (Figure 18). In the primary perspective of the Iranian Garden, the foreground, middle ground, and background are combined to form a unified image

(Figure 19). Hierarchy, as a feature, plays a significant role in creating harmonized layers in depth. This form of integration entails the simultaneous separation and integration of the inside and innermost layer with the outside and outermost layer (Figures 20 & 21). In layers accompanying in height, there exist high and higher layers of space (Figure 22).

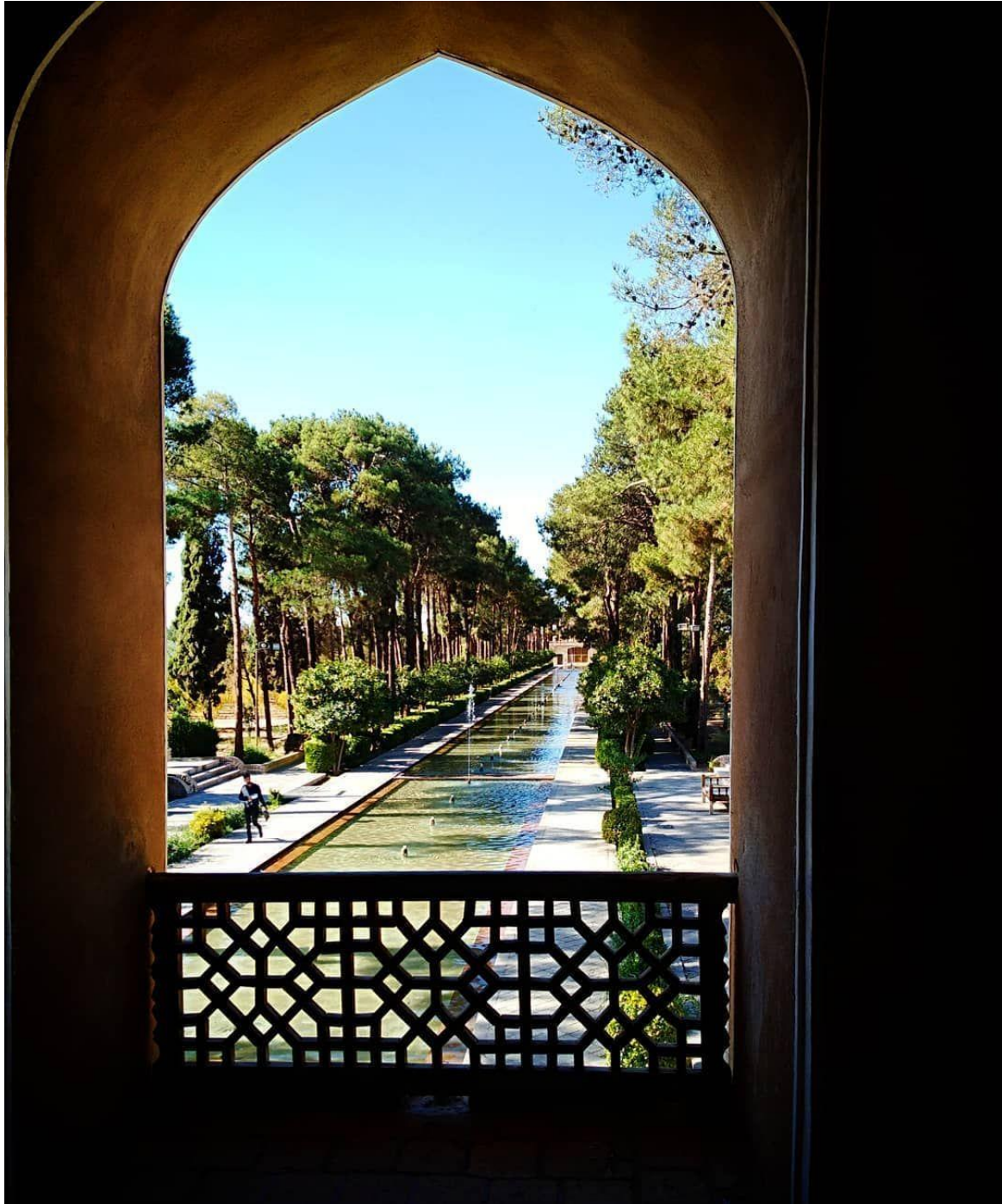

Fig 16. Framing the landscape of the garden, Dowlatabad Yazd Garden.

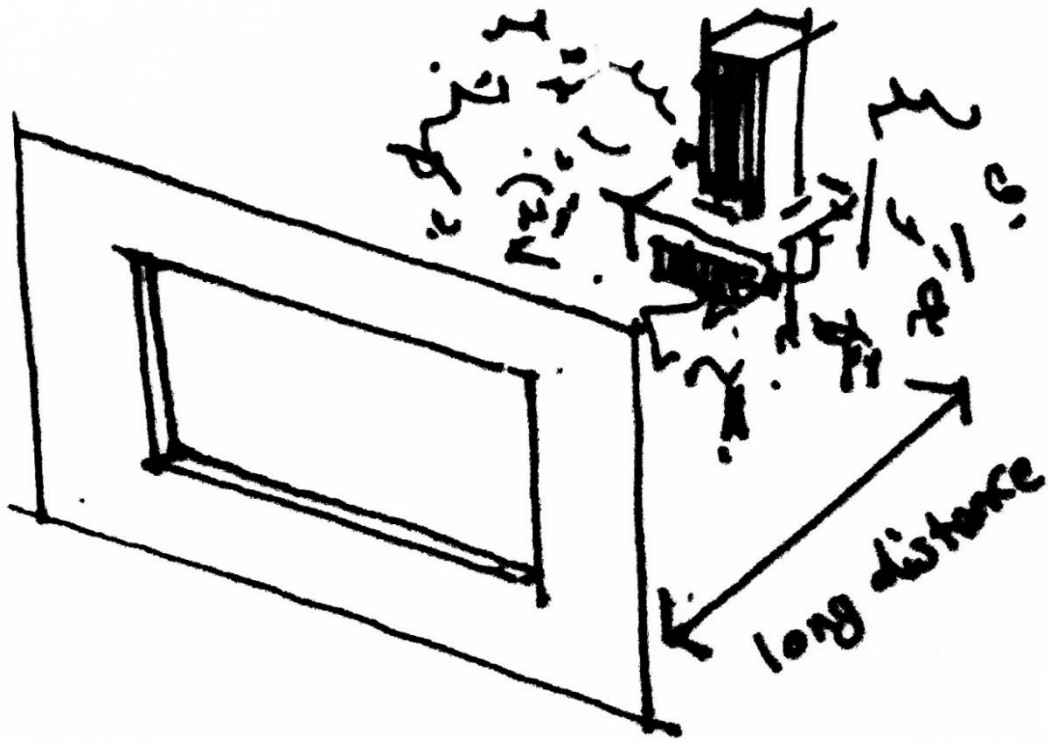

Fig 17. Converting a 3D space into a 2D image by framing

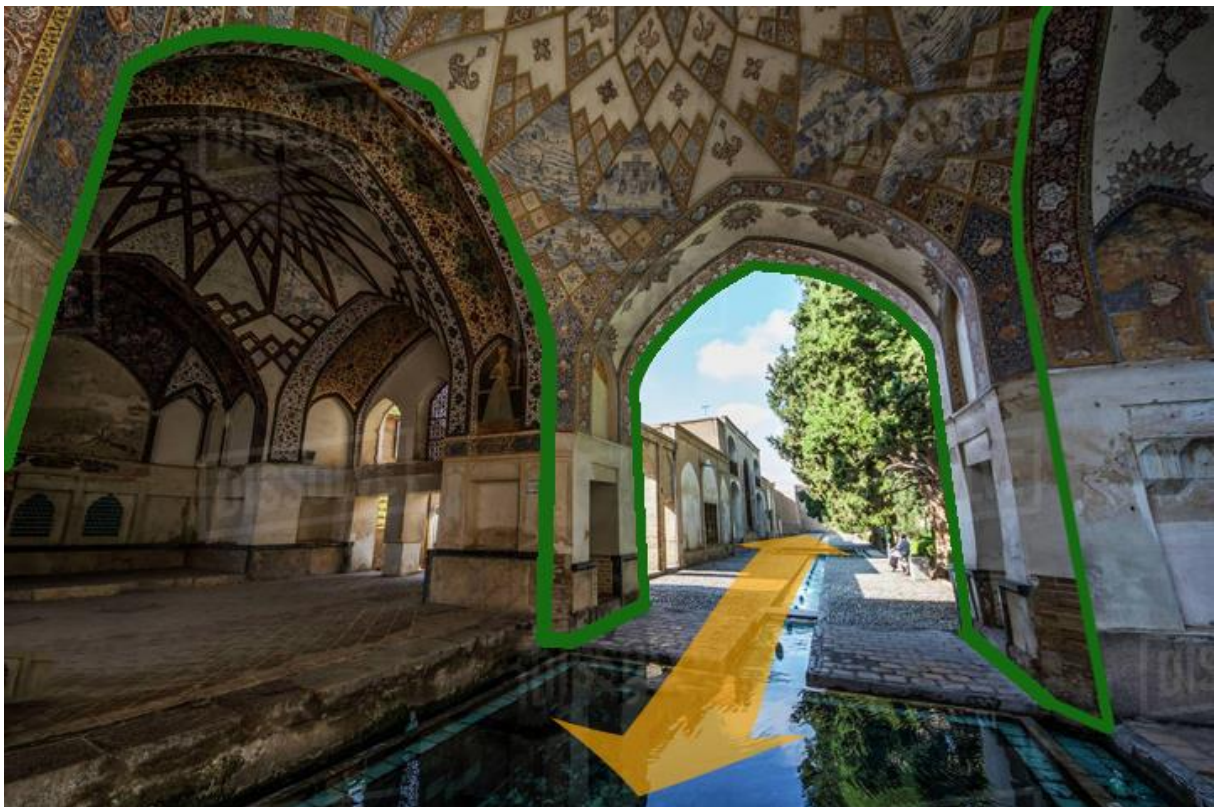

Fig 18. Permeability, extension and sequence of spaces, Fin Garden.



Fig 19. Overlapping elements of reality, Fin Garden.

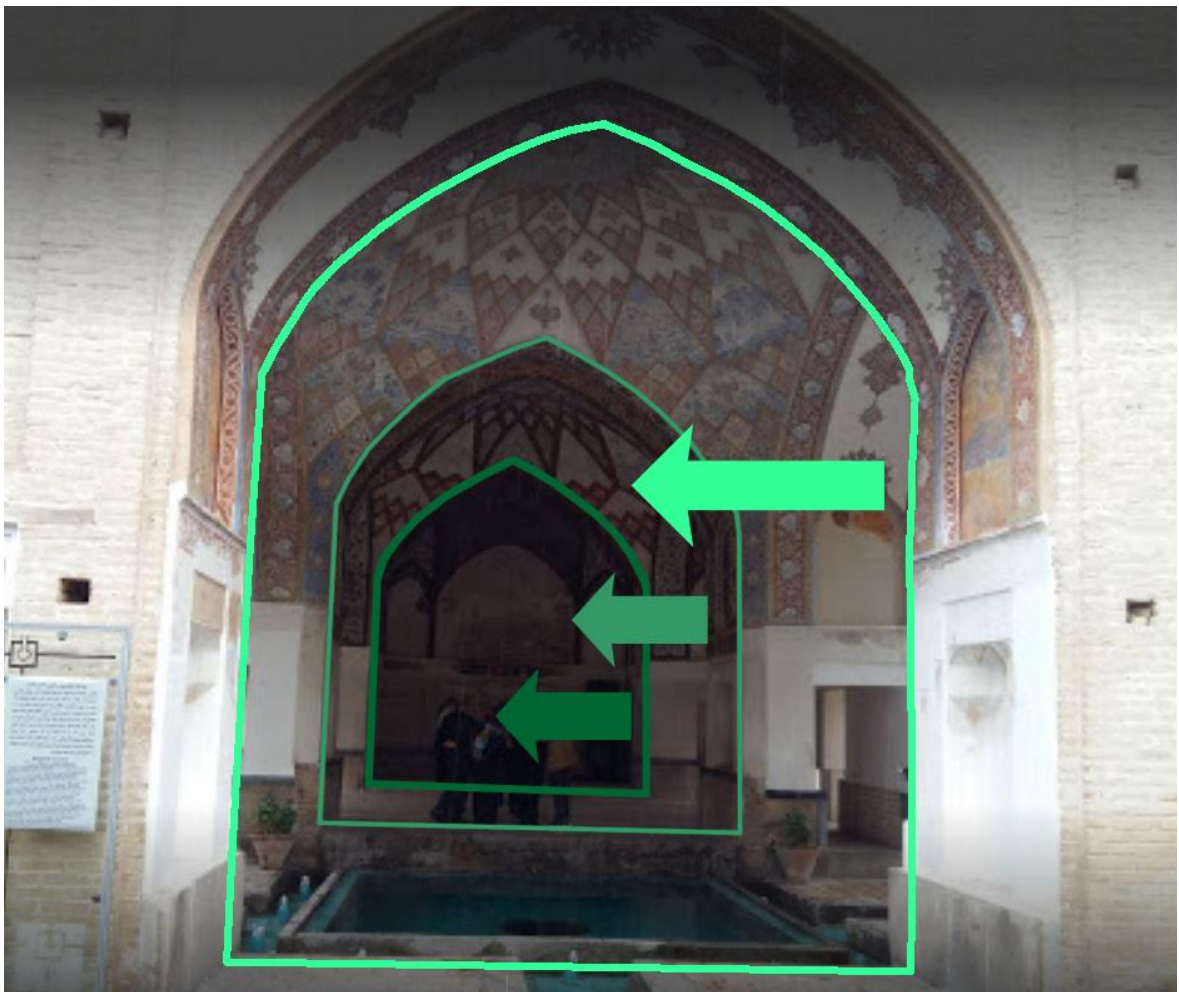

Fig 20. Accompanying layers in depth, Fin Garden.

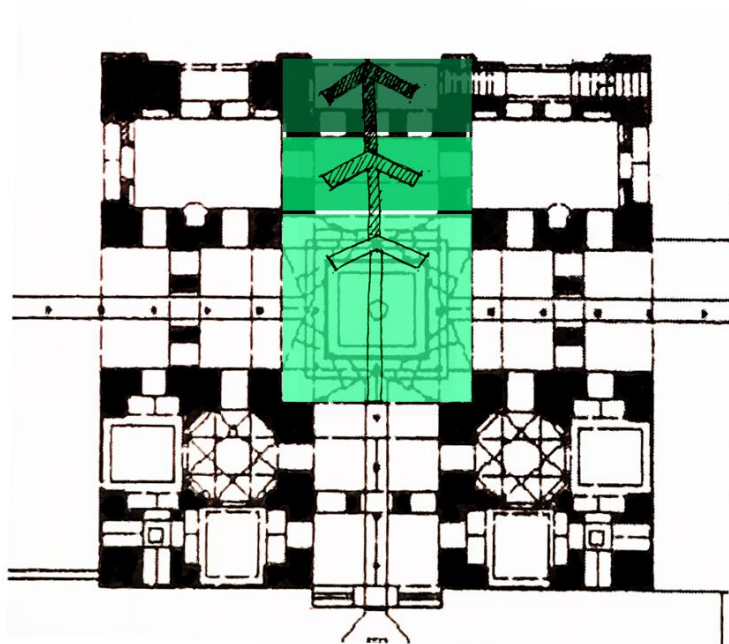

Fig 21. Accompanying layers in depth, plan, Fin Garden.



Fig 22. Accompanying layers in height, Fin Garden.

A fundamental aspect of this method of re-presenting reality involves the demarcation and layering of reality through various elements like walls or trees. These borders and thresholds serve to define space and re-present the reality of the garden. For instance, the walls surrounding the garden create an inside and an outside, while lines of trees delineate the main axis of the garden, simultaneously separating and uniting pathways and green spaces (Figure 23 and 24).

In Iranian gardens, the integration of reality and virtual reality unfolds in two distinct ways. Firstly, through the simultaneous presence of the image and the real. Secondly, through the presence of symbols and the real. For instance, when the image of the pavilion (Kushk) is reflected in the water of the pool, the virtual image of the building in the water seamlessly integrates with the real image, thus creating a re-presentation of reality (Figure 25). This

deliberate synergy between image and reality is a carefully orchestrated aspect of Iranian Gardens. Moreover, Iranian gardens incorporate numerous symbolic elements, such as sacred geometry or the dome, which represent concepts like the sky or the

heavens. In specific locations, these symbolic elements are integrated with natural elements, presenting a re-presentation of reality by harmonizing the real with the virtual (Figure 26).



Fig 23. Disjunction of inside and outside the garden, Fin Garden.

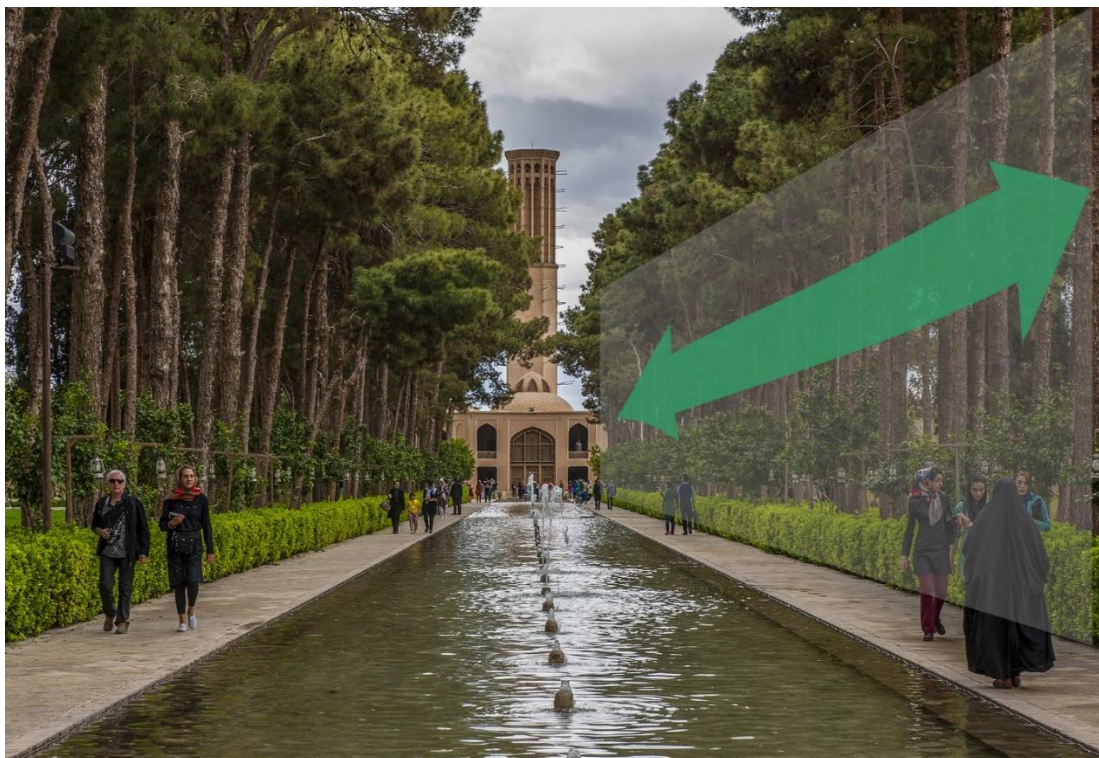

Fig 24. Demarcation of spaces inside the garden, Dowlatabad Yazd Garden.



Fig 25. Integrating real and virtual image, Shazdeh Mahan Garden.



Fig 26. Symbolic element in combination with natural and real elements (dome symbolizing sky), Fin Garden.

6.3. The Transformation of Reality

This strategy differs from the other two, as it involves altering reality or expressing a modified or alternative version of it. The modified expression of reality is achieved by combining different effects or, at times, by introducing ambiguity or deception. In the Iranian Garden, the transformation of reality unfolds in three ways: transformation in the main features of a phenomenon, creating ambiguity and optical illusion, and masking and veiling of reality. For example,

painting window glasses to change the color of light or painting the pool blue to alter the perception of water are instances of the transformation of reality by changing the features of a phenomenon (Figures 27 & 28). In the main perspective of Shazdeh Garden, the distance between the entrance and the main building (pavilion) appears shorter than reality—a visual illusion caused by the sloped path (Figures 29 & 30). The use of one-point perspective in the main axis is another visual technique that alters the perception of space (Figure 31).



Fig 27. Transformation of reality through changing the color of light with painted glass windows, Dowlatabad Yazd Garden.

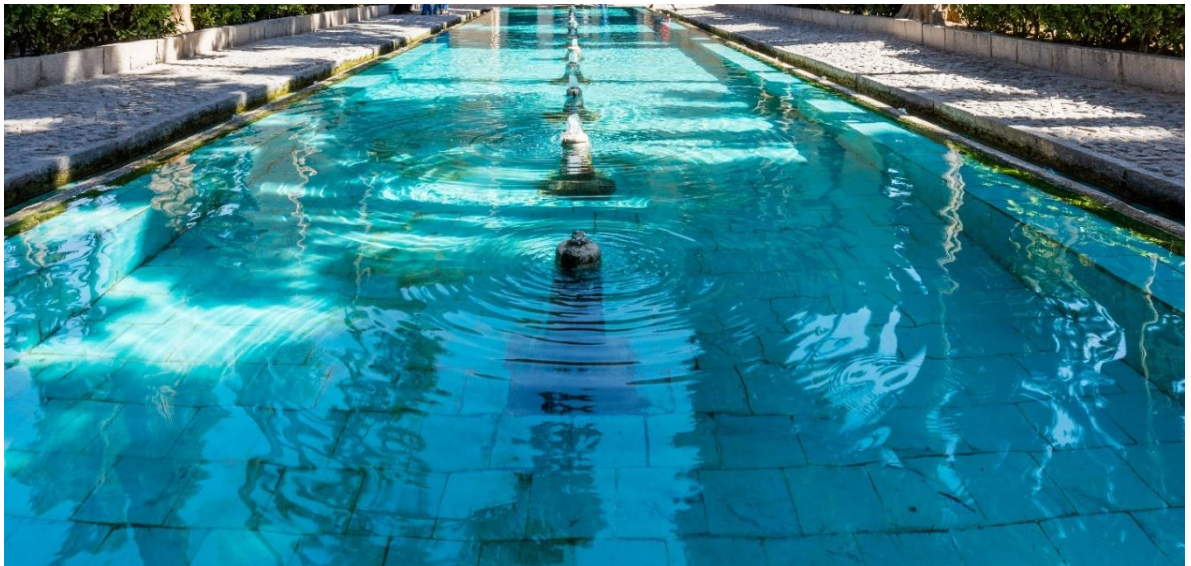

Fig 28. Imagining blue water by painting the pool surfaces, Fin Garden.



Fig 29. Creating ambiguity and optical illusion, Shazdeh Mahan Garden.

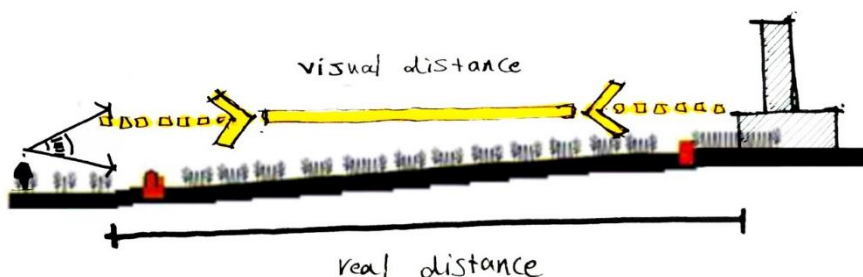

Fig 30. Reducing visual distance by creating optical illusion



Fig 31. Minimizing dimensions by creating a one-point perspective on the main axis, Shazdeh Mahan Garden.

The objectification of mental imagery, which involves the transformation of mental reality into lived reality, is evident in the Iranian Garden through the narration of stories or historical characters and the representation of natural elements in the form of wall paintings. For instance, depictions of historical events related to the garden's history adorn the walls and ceilings of the garden (Figure 32). Additionally, trees are presented both abstractly in paintings and in a

tangible, objective manner within the garden spaces (Figure 33).

These gardens also employ the strategy of masking and veiling reality. Colored glass windows, Moshabak, and strategically placed trees adjust visual access, creating one-way transparency and masking important spaces. Masking and veiling play a significant role in Iranian spatial design by regulating the relationship between the interior and exterior. This process of

masking and veiling contributes to the gradual and hierarchical perception of reality, ultimately altering the viewer's understanding of reality (Figures 34 & 35 & 36). An overview of all these components related to the three methods of representing reality in the Iranian Garden is presented in Table 3.

7. CONCLUSION

This research has thoroughly examined the diverse strategies employed in the architecture of the Iranian Garden to re-present reality, showcasing it as a rich cultural and historical example of spatial design in Iran. The study systematically classified these strategies into three categories: intensification, integration, and transformation of reality. Subsequently, a detailed analysis of the design techniques used in the Iranian Garden validated this classification, highlighting how a blend of natural and man-made elements contributes to a unique representation of reality.

The findings demonstrate that each of the three strategies for representing reality within the Iranian Garden stimulates both the body and the mind. In the intensification of reality, techniques such as unifying disparate elements, fostering a desire for movement,

pairing contrasting elements, and creating spatial variety effectively enhance the visitors' experience. The integration of different layers of reality involves demarcating, layering, and integrating different realities through features like transparency, permeability, overlapping, veiling, framing, and the creation of merged and interpretable imagery. In the transformation of reality, architectural elements such as color, transparency, optical illusion, masking and veiling, symbols, and both abstract and natural elements like water and plants are used to introduce ambiguity, visual trickery, curiosity, and imagination, altering the viewers' perception and experience of reality.

In conclusion, the Iranian Gardens studied exhibit a sophisticated and diverse application of techniques for intensifying, integrating, and transforming different realities. These designs actively engage both the body and the mind, leaving a lasting and transcendent impression on visitors. The hope is that such interpretations of traditional Iranian Gardens will guide future designers in recreating the same spatial qualities without merely repeating familiar motifs and forms. Additionally, a deeper understanding of how the Iranian Garden re-presents the familiar will inform efforts to evolve it for modern times, preventing deviations that might compromise its essence.



Fig 32. Realization of mental facts and historical events, Fin Garden.

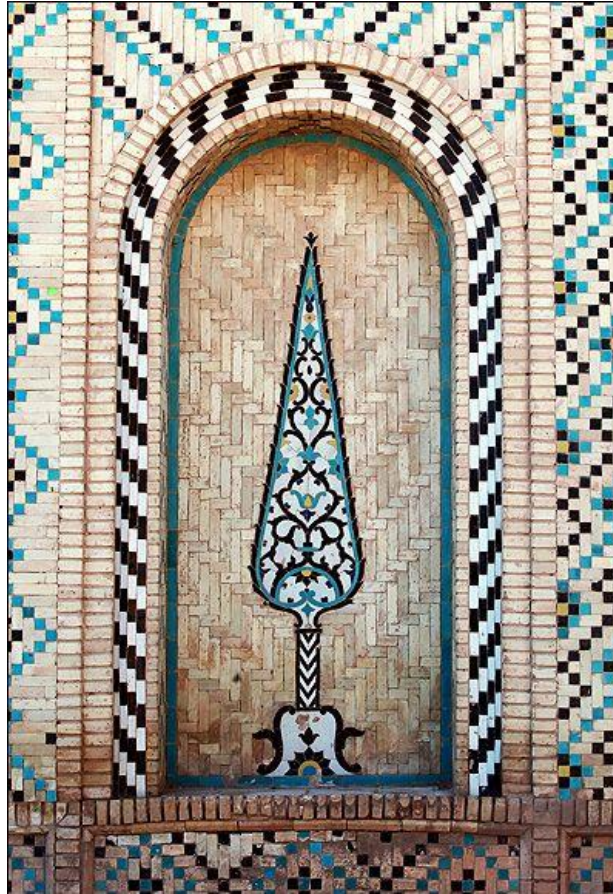

Fig 33. Symbolic re-presentation of natural elements such as tree in wall paintings, Dowlatabad Yazd Garden.



Fig 34. Masking and veiling the inside, Dowlatabad Yazd Garden.

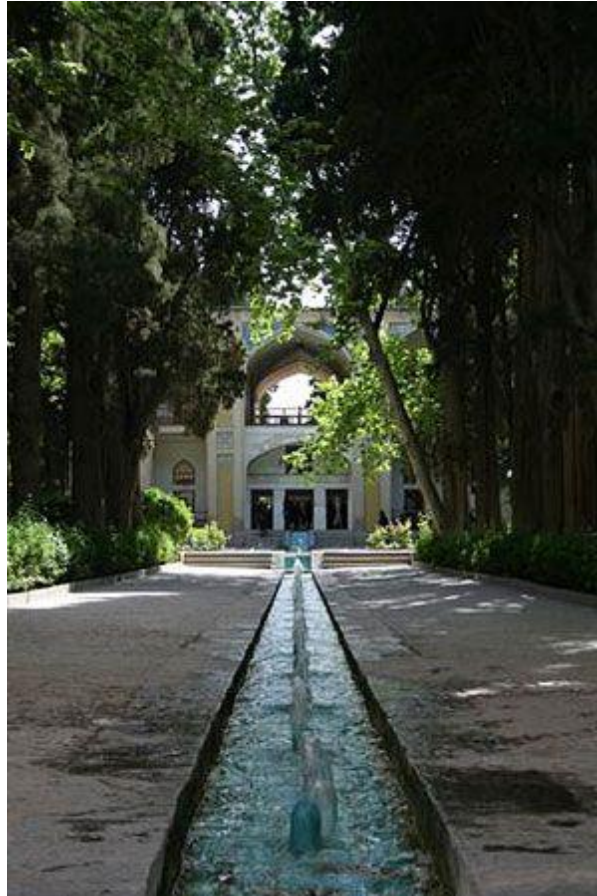

Fig 35. Creating a hierarchy of vision using trees, Fin Garden.

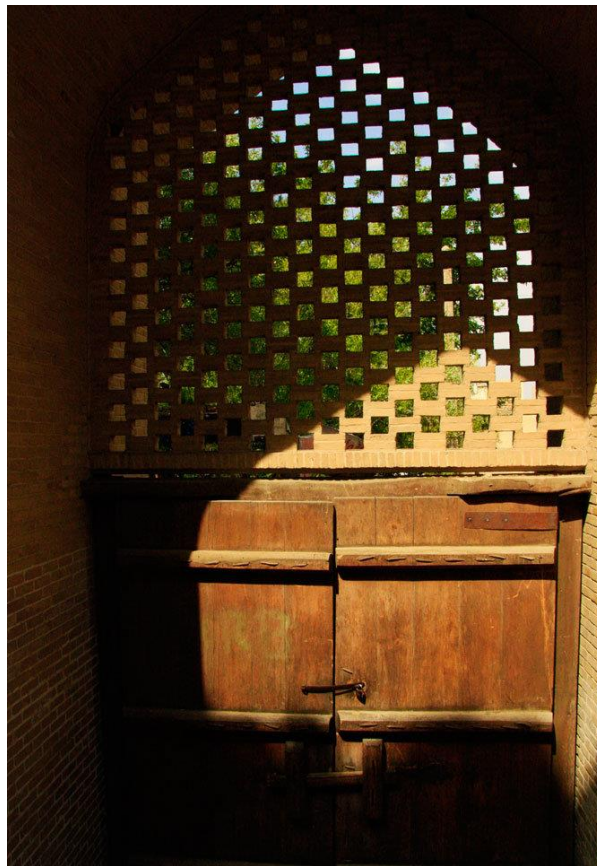

Fig 36. Masking the inside by Moshabak, Fin Garden.

Table 3. The components of the three methods of representation of reality in the Iranian Garden

Methods of representing reality in Iranian Gardens	Intensification	Convergence and unity of the elements	<ul style="list-style-type: none"> - Homological element - Compatible elements
		Attraction and motivation for movement	<ul style="list-style-type: none"> - A network of main and secondary axes - Strengthen the garden-centric forces by focusing on a certain element of reality - Extending the movement of the axes - Utilize the sense of muscle
		Creating variety in the perception of space	<ul style="list-style-type: none"> - To simulate all the five senses in creating different view of a certain reality - Instant and gradual changes in visual sequences
		Accompaniment of contrasting dual elements	<ul style="list-style-type: none"> - Contradiction of silence and sound - Vertical direction contrast in horizontal direction - Contrast of movement and stillness - Contrast of light and darkness - Contradiction of simplicity and complexity
	Integration	Demarcation and/or integration of layers of reality	<ul style="list-style-type: none"> - Permeability, extension and sequence of spaces - Overlapping elements of reality - Accompanying layers in depth and height - Disjunction and demarcation of spaces - Displaying reality by framing
		Integrating real and virtual images	<ul style="list-style-type: none"> - Create a virtual image of the real image by reflective elements such as water - Symbolic ornaments in merging with real elements
	Transformation	Creating a new reality by altering component features	<ul style="list-style-type: none"> - Change in the nature and structure of reality (change in the color of natural elements such as light and water)
		Ambiguity and illusion	<ul style="list-style-type: none"> - Minimize and reduce dimensions by creating perspective - Close-up: reduce visual distance
		Objectification of mental facts	<ul style="list-style-type: none"> - Representation of natural elements and mental stories - Memory-making elements and return to mental memories - Narration of stories and historical characters of the past
		Masking and veiling of reality	<ul style="list-style-type: none"> - Masking and veiling for the interior space with colored glass windows. - Creating a visual hierarchy and demarcating spatial boundaries

REFERENCES

- Baudrillard, J. (1983). *In the Shadow of Silent Majorities*. (p. p. Paul Foss, Trans.) New York: Columbia University.
- Baudrillard, J. (1990). *Seduction*. Montreal: New World Perspectives.
- Baudrillard, J. (1994). *Simulacra and Simulation*. Ann Arbor: University of Michigan press.
- Bohme, G. (2013). Atmosphere as Mindful Physical Presence in Space. *OASE*, (91), 21-32.
- Dawey, N., & Malpas, J. (2016). *The {Stanford} Encyclopedia of Philosophy: Gadamer's Aesthetics*. United States: Metaphysics Research Lab, Stanford University.
- Flach, J. (1998). The Reality of Experience: Gibson's Way. *Presence Teleoperators & Virtual Environments*, 90-95.
- Gadamer, H. G. (1986). *The Relevance of the Beautiful and Other Essays*. (R. Bernasconi, Ed., & N. Walker, Trans.) Cambridge: Cambridge University Press.
- Gómez, A. P. (2006). The Space of Architecture: Meaning as a Presence and Representation. In J. P. Steven Holl, *Questions of Perception: Phenomenology of Architecture* (pp. 7-25). San Francisco: William Stout.
- Graham, G. (2006). *Philosophy of Art; An Introduction to Aesthetics*. Abingdon: Taylor & Francis.
- Hale, J. A. (2017). *Merleau-Ponty for Architects*. Abingdon: Routledge.
- Helmholtz, H. v. (1962). *Helmholtz's Treatise on Physiological Optics*. New York, United States: Dover Publications.
- Holl, S. (2006). Questions of Perception- Phenomenology of Architecture. In J. P. Steven Holl, *Questions of Perception: Phenomenology of Architecture* (pp. 39-135). San Francisco: William Stout.
- Hursthouse, R. (1992). Truth and Representation. In O. Hanfling, *Philosophical Aesthetics: An Introduction* (pp. 239-296). Kiribati: Wiley.
- Kidder, P. (2013). *Gadamer for Architects*. Abingdon: Routledge.
- Mallgrave, H. F. (2011). *The Architect's Brain: Neuroscience, Creativity and Architecture*. Chichester: Wiley-Blackwell.
- Nader Ardalan, L. B. (1973). *The Sense of Unity: The Sufi Tradition in Persian Architecture*. Chicago: The University of Chicago Press.
- Pallasmaa, J. (2009). *The Thinking Hand: Existential and Embodied Wisdom in Architecture*. United Kingdom: Wiley.
- Pallasmaa, J. (2011). *The Embodied Image: Imagination and Imagery in Architecture*. United Kingdom: Wiley.
- Pallasmaa, J. (2014). Space, Place, and Atmosphere. Emotion and Peripheral Perception in Architectural Experience. *Lebenswelt-aesthetics and Philosophy of Experience*, 230-245.
- Puglisi, L. P., Byatt, L., & Saggio, A. (1999). *Hyper Architecture: Spaces in the Electronic Age*. Germany: Birkhauser-Publishers for Architecture.
- Schnabel, M. A., & Wang, X. (Eds.). (2009). *Mixed Reality in Architecture, Design and Construction*. Germany: Springer Netherlands.
- Tuan, Y.-F. (2001). *Space and Place: the Perspective of Experience*. Minneapolis: University of Minnesota Press.
- The Oxford English Dictionary* Vol. 7. (1913). Retrieved from <https://archive.org>.
- Zumthor, P., & Oberli-Turner, M. (1998). *Thinking Architecture*. Switzerland: Princeton Architectural Press.

AUTHOR (S) BIOSKETCHES

N. Maleki Sadeghi., *School of Architecture, College of Fine Art, University of Tehran, Iran*

Email: negar_maleki@ut.ac.ir

S. Y. Islami., *School of Architecture, College of Fine Art, University of Tehran, Iran*

Email: y.islami@ut.ac.ir

COPYRIGHTS

Copyright for this article is retained by the author(s), with publication rights granted to the journal.

This is an open-access article distributed under the terms and conditions of the Creative Commons Attribution License (<http://creativecommons.org/licenses/by/4.0/>).

HOW TO CITE THIS ARTICLE

Maleki Sadeghi, N., Islami, S.Y. (2023). Beyond the Real Methods of Re-presenting Reality in Iranian Gardens. *Int. J. Architect. Eng. Urban Plan*, 33(4): 1-27, <https://dx.doi.org/ijaup.750>.

URL: <http://ijaup.iust.ac.ir>

