

Lighting programme and iranian schools lighting requirements

Yousef Gorji Mahlabani^{1,*}, Mohsen Faizi², Mehdi Khakzand³

Received: June 2010, Accepted: March 2011

Abstract

It is accepted that the visual comfort in schools depends on the quality of the whole visual environment. This leads to the concern upon the quality and quantity of lighting. Currently in Iran, in order to calculate energy transfer for public buildings a coefficient is usually used. This coefficient considers the rate of sunlight energy absorption in these kinds of buildings. To increase the degree of accuracy in the calculation mentioned above, the authors suggest a simulation programme that can do the job precisely and accordingly. It seems that, in order to calculate the energy requirements of school buildings in Iran for heating, cooling and lighting, it is better to use a simulation programme, too. In fact, this paper considers details of lighting as part of a comprehensive programme and Iran schools design requirements for lighting. As we will see, this research describes the method of calculation of daylighting, which is used in the part of lighting simulation programme. Effective daylighting design requires consideration of different factors such as daylight factor, luminous efficacy of solar radiation, orientation factor, glass transmittance factor, average reflectance of material and etc. which are need for calculation of exterior and interior luminance. They are discussed in details in this paper.

Keywords: school lighting design, lighting design factors, admittance programme, daylighting analysis programme

1. Introduction

One of the essential factors in the design of school buildings is lighting. It is necessary in every building, especially in schools where good natural lighting is required. A successful school design depends to a great deal on the quality of the visual environment [1]. Therefore, architects should keep in mind that good lighting condition is very important in providing a suitable educational environment.

Different criteria of lighting design are: Task/activity lighting, Lighting for visual amenity, Lighting and architectural integration, Lighting maintenance, Lighting and Energy efficiency. The role of these criteria in the lighting design will not be equal. However, in order to achieve the best solution all should be taken into account [2].

The designer needs to consider the functional requirements of the special space. It is essential to examine the type of lighting required and the amount of light to be certain that the occupants of the space can carry out their special activities without visual difficulty and in a comfortable visual

environment. Therefore the activity requirements for particular spaces have to be analysed.

In order to allow for various tasks it may be necessary to provide flexibility in the lighting. Local task lighting can be very useful for particular activities. One of the important factors that should be considered in selecting the type of local task light (such as surface temperature of the fitting) is safety. One of the alternatives to higher levels of illuminance (especially for the visually impaired) is an increase in the contrast or the size of the task detail.

This feature of lighting addresses the appearance of the lit scene and the aim is to create a visually interesting and pleasant environment. This means producing a light pattern that has variation in the luminance and a sensitive use of surface colour. The installation of natural and electric lighting has to be integrated in the architecture. This will apply to the lighting elements, i.e. windows and luminaries, and their production of light patterns.

This will lead to the maximum use of daylight by using electric light to complement daylight and using energy-efficient electric lighting that only works when it is required. This last point can be dealt with the positions of the control switches, the organisation of the lighting circuits to have a connection with the daylight distribution and the use of the space. Useful energy savings can be provided by automatic controls however, it is necessary that any controls are used friendly, i.e., they do not restrict the use of the space [3].

* Corresponding Author: yosefgorji@ikiu.ac.ir
1 Assistant Professor, Faculty of Architecture and Urban Development, Imam Khomeini International University
2 Associate Professor, School of Architecture and Environmental Design, Iran University of Science and Technology
3 Assistant Professor, Faculty of Environment, University College of Fine Arts, University of Tehran

The type of luminaries should be selected with the aim of giving an average initial circuit luminous efficacy of 65 lumens per circuit watt for the fixed lighting equipment within the building. Emergency lighting systems and equipment, which are not fixed such as, track-mounted luminaries, are excluded from this figure [4].

Martinot & Borg [5] analyze ten case studies of energy-efficient lighting programs in eight countries -Poland, Thailand, Mexico, Jamaica, Peru, Brazil, Denmark and the United Kingdom- to draw out and compare the lessons and experience related to program approaches, technology diffusion and market transformation impacts, cost effectiveness of greenhouse-gas reductions, and economic benefits. Program approaches include direct subsidies, wholesale buy-downs, bulk procurement, give-aways, education, voluntary agreements, and consumer financing mechanisms. All approaches were adequate to deliver a targeted quantity of high-efficiency lamps to consumers, but differed substantially in their cost-effectiveness, economic benefits and market transformation effects.

As can be seen in the article, the lighting requirement of schools in Iran mainly by daylight and to use electric lighting, has argued.

Daylight includes direct sunlight; diffuse sky radiation which has argued by Marks [6] also reflected Light by others [11].

Lighting Design Criteria like Daylighting, Glare, Electric Lighting, Combined Daylighting and Electric Lighting, Lighting Quantity & Quality, Emergency Lighting, Positioning and Use of Colour discussed here. Also Lighting for Pupils with Visual Impairments as another Lighting Design Criterion has argued.

In the area of Design of Shading Devices, Givoni [7] argues about the importance of shading in different climates, Also Koenigsberger, et al. [8] notes on Determination of Shading Devices. In this area Economy of Shading Devices and Shading Effect of Trees and Vegetation is considered.

As mentioned before Daylight Quantity calculation and its factors is one of the main goals of this paper.

The programme used in this research has been developed from the Admittance procedure given in the Chartered Institute of Building Services (CIBSE) Guide Book A - Section A6. The Equations Used within the Excel Programme has argued. On the other hand, Operation of the Admittance Model and the Outputs are discussed.

According to mentioned points, the aims of this article can be considered as below:

- To consider different factors for Effective daylighting design
- To discover Iran schools design requirements for lighting
- To Develop a programme in order to calculate the energy requirements of school buildings in Iran
- To declare the necessity of visual environment in schools design

2. Lighting

Key elements in the design of an energy efficient lighting system are the integration of the electric lighting with daylight to avoid unnecessarily high levels of electric lighting.

Inevitably, daylight will need to be supplemented by electric lighting. To successfully do this, a knowledge has to be gained of the illuminance due to daylight throughout the day and throughout the year. Therefore, it is necessary to calculate the illuminance due to daylight. This section describes the method of estimation of this illuminance, which is used for the calculation of lighting loads in school buildings in Iran.

The main strategy of lighting programme is to provide the lighting requirements of schools in Iran mainly by daylight and to use electric lighting when adequate daylight is not available. In order to calculate the lighting loads in different spaces of school building in this research the building code of Iran [9] has been used.

3. Daylighting Definition

Daylight or the light of day is the combination of all direct and indirect sunlight outdoors during the daytime (and perhaps twilight). This includes direct sunlight, diffuse sky radiation, and (often) both of these reflected from the Earth and terrestrial objects. Sunlight scattered or reflected from objects in outer space (that is, beyond the Earth's atmosphere) is generally not considered daylight. Thus, moonlight is never considered daylight, despite being "indirect sunlight". Daytime is the period of time each day when daylight occurs.

Daylight is present at a particular location, to some degree, whenever the sun is above the horizon at that location. However, the outdoor illuminance can vary from 120,000 lux for direct sunlight at noon, which may cause eye pain, to less than 5 lux for thick storm clouds with the sun at the horizon (even <1 lux for the most extreme case), which may make shadows from distant street lights visible.

3.1. Daylighting design

In recent years, the sustainable design movement has returned daylighting to the fore of mainstream construction. In its simplest definition, daylighting is the use of daylight as a primary source of illumination to support human activity in a space.

Daylight is the result of the scattering of the solar beam in the atmosphere, and its inter-reflection and absorption at the earth's surface. It varies with the position of the sun in the sky, weather and terrain. The light falling on a window has three separate elements for architectural design; direct sunlight, diffuse light from the sky and light reflected from the ground and other buildings.

3.2. Direct sunlight

Sunlight, in the broad sense, is the total frequency spectrum of electromagnetic radiation given off by the Sun. On Earth, sunlight is filtered through the Earth's atmosphere, and solar radiation is obvious as daylight when the Sun is above the horizon. When the direct solar radiation is not blocked by clouds, it is experienced as sunshine, a combination of bright light and radiant heat. Direct sunlight has a luminous efficacy of about 93 lumens per watt of radiant flux, which includes infrared, visible, and ultraviolet light. Bright sunlight provides illuminance of approximately 100,000 lux or lumens per

square meter at the Earth's surface [10].

The intensity of direct sunlight varies with the length of the beam's path through the atmosphere. It also depends on the atmospheric turbidity, which determines the amount that the solar beam is scattered and absorbed along its path. Although the prediction of the sun's position in the sky can be made precisely that is dominated by the presence of cloud, the occurrence of sunlight on the ground can be specified only in terms of frequency distributions (based on meteorological records). The intensity of the sun's beam is given in term of solar illuminance, which shows the amount of light falling on a surface directly facing the sun. The probability of sunlight is expressed by relative sunshine duration, the ratio of actual sunshine hours to the sunshine hours that would occur with cloudless skies. The description of atmospheric turbidity is made by the linked turbidity factor. This factor is the ratio of the optical thickness of a moist turbid atmosphere to that of a clean dry atmosphere, considering total solar radiation [11].

3.3. Diffuse Light from the Sky

When light strikes a rough or granular surface, it bounces off in all directions due to the microscopic irregularities of the interface. This is called diffuse reflection. The exact form of the reflection depends on the structure of the surface. As sunlight passes through the atmosphere, a portion is scattered by dust, water vapour and other suspended particles. This scattering, acting in concert with clouds, produces sky luminance. Skies are divided into three categories: clear, partly cloudy and cloudy.

When the sky is not completely overcast, the sky luminance distribution may change rapidly and by large amounts as the sun is alternately obscured, partly obscured or fully revealed [6].

3.4. Reflected Light

Reflection is the change in direction of a wavefront at an interface between two different media so that the wave front returns into the medium from which it originated. Direct sunlight is associated with overheating in hot climates. Therefore, windows are often designed to exclude it and solar control has a major role in the design of buildings in these types of climate. In order to exclude direct sunlight, shading devices can be used on windows.

However, the amount of sky visible from the interior will be also reduced and the entry of skylight will be restricted. In such circumstances sunlight reflected from external surfaces, the ground and opposite buildings, can be a major source of diffuse light. It may provide the main daylighting in an interior. In cool climates, when windows are designed for overcast sky conditions, the externally reflected light is usually only a small fraction of the total daylight entering a room. However, sky brightness is affected by ground reflection [11]. There is significant inter-reflection between ground and clouds with large areas of light-coloured ground surface. Approximate values of reflectance differ from 0.05 for black coloured surface to 0.85 for white. In order to know these values under diffuse daylight of building materials see British Standard [12].

4. Lighting Design Criteria

4.1. Daylighting

Daylight should be the principal light source in the design of schools. The colour of the window wall should be light; in order to reduce contrast with outdoor scene, and window reveals may be splayed to increase the apparent size of the glazing. Depending on the type of visual impairment, sunlight can be either help or an obstruction. Therefore, some means for the control of its quantity should be provided. Traditionally this has been by means of blinds. In circulation spaces, the design of fenestration should decrease glare hazards. Large areas of glazing should be clearly seen. Otherwise, it can be dangerous to the people with visual impairment. They can be marked with a contrasting feature at eye level in order to avoid accidents. This will make them visible even in low light levels.

It has been suggested that the minimum level of daylight in school buildings should be 2% day light factor [13]. The daylight factor is defined as that percentage of the outside level reaching the working plane from the outside. This includes the light reflected from internal and external surfaces (see figure1). Windows should provide light and view in school buildings. In table1 the size of openings, which provides the 2% daylight are shown in percentage [13].

Side windows or rooflights can obtain these percentages. By using rooflights the capital cost will increase and the view out will be eliminated [13]. Also, they will be difficult to shade and protect from direct sun. Side windows; provide light, view out, fresh air and possible escape [1]. The size of windows should be considered in the climate of Iran (especially in centre and south). Alan Konya suggests medium sized windows to ensure good airflow during summer and allow the penetration of sun during winter [14]. The quality of good lighting can be obtained without excessively large areas of glass. During daylight hours, natural light should be the first means of lighting. A space is likely to be considered well lit if

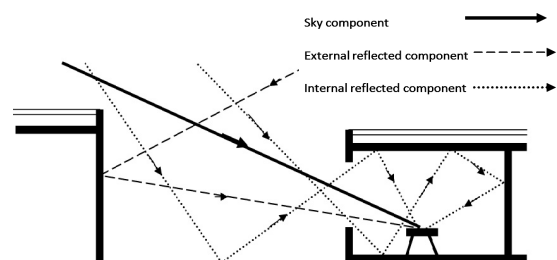

Fig. 1. Daylight factor components (designed by authors)

Table 1. Percentage of openings to the depth of the teaching space [13]

Maximum perpendicular depth of the teaching space from an external wall in meters	Less than 8 m	8-11 metres	11-14 metres	More than 14 m
Maximum percentage internal elevation of the external wall area	20%	25%	30%	35%

the average daylight factor is 4-5%. For the daylight illuminance to be adequate for the task, it will be necessary to achieve a level of not less than 300 lux in the classrooms and for particularly demanding tasks not less than 500 lux. When this level cannot be obtained, it will be necessary that the daylight be supplemented by electric light. Sometimes, light exterior surfaces can be used in order to increase reflected light [9] and [2].

The window design should be relevant to the layout and activities, which, are planned for the internal space (for example, to avoid silhouetting effects and excessive contrasts in brightness). Daylight and particularly direct sunlight can cause discomfort and disability glare. This problem can often be resolved by careful and appropriate design of the window to minimise glare. The other alternative is to provide adjustable blinds in order to screen the glare source when necessary. Also, blinds can improve the thermal environment by decreasing heat gains. External blinds are more expensive than the internal blinds. Nevertheless, external blinds are more effective in preventing solar heat gain. Internal blinds are often difficult to maintain. Also, they are a source of noise when windows are open. Traditional architectural forms in Yazd were able to aid in the control of the internal environment through such devices as wind catchers to help in providing natural ventilation and dome structures to provide daylight and ventilation. In this research the author is interested in optimising school design in different climate zones in Iran. Devices, which may be appropriate in one climate zone may not be appropriate in another and therefore the author felt that to investigate the use of traditional forms would (although interesting) fall outside the scope of his work.

Windows provide natural variation of light through the day and external visual interest. Therefore, for the window area to be adequate for this purpose, for example in Babolsar, it is recommended that a minimum glazed area of 20% of the internal elevation of the exterior wall be provided. Windows need to be also examined in terms of other environmental factors such as, the thermal and acoustic performance together with the energy efficiency of the building.

4.2. Glare

In order to obtain a good visual environment, it is recommended that equilibrium of brightness throughout the room and a balance of direct and indirect lighting be achieved. This prevents the impacts of glare. The glare index for each space in a school is illustrated in the table 2 Glare can be caused by bright areas of sky seen through windows, projection of sunlight on desks and chalkboards, unscreened lamps, fluorescent lamps, etc. To avoid the inconveniences caused by glare it is recommended to:

- Avoid putting windows on the visual focal points (for example chalkboards).
- Increase the general brightness of the room by selecting the appropriate colour for ceilings and walls (bright colours are desirable).
- Use blinds, curtains, screens and other shading devices [1].

Table 2. Illuminance, uniformity ratio and limiting glare index for schools [2]

General Teaching Spaces	Standard maintained illuminance-Lux	Uniformity Ratio	Glare index
	300	0.8	19
Teaching Spaces with Close and Detailed Work (e.g., Art and Craft Rooms)	500	0.8	19
Circulation Spaces:			
Corridors, Stairs	80-120	--	19
Entrance Halls, Lobbies& Waiting Areas	175-250	--	19
Reception Areas	250-350	--	19
Atria	400	--	19

4.3. Electric Lighting

The electric lighting installation has to provide all the requirements illustrated in the design framework. According to task lighting, for most school tasks, an illuminance of 300 lux will be suitable. If the task is particularly demanding (e.g., the task detail content is small or it has a low contrast) a value of not less than 500 lux will be necessary: in some circumstances, this can be obtained by a local supplement to the general lighting. Although the human eye is able to operate in low lighting levels there is strong evidence that visual acuity drops off with low levels [15]. Therefore in an education environment where reading plays an important part of the daily tasks it is necessary to ensure that the eye can function efficiently with minimum strain. It is therefore suggested that design guidelines adopted in countries where research effort has been carried out into visual acuity are adopted. For stairs and corridors a maintained illuminance at floor level in the range 80-120 lux is recommended. Entrance halls, lobbies and waiting rooms need a higher illuminance in the range 175-250 lux at an appropriate level. Reception areas should be lit to a level in the range 250-350 lux on the working plane (see table 2).

In order to avoid from discomfort glare, where a regular arrangement of luminaries is used, the Glare Index shall be limited to no more than 19 [16]. Also, it will be important to avoid visual discomfort from individual luminaries and from reflected images, particularly on computer screens.

The avoidance of subliminal lamp flicker is another consideration on visual comfort. This is important because it can induce epileptic fits in susceptible pupils. It can be minimised by using high frequency control gear or using more than one phase of a three-phase supply in a lead-lag arrangement. The stroboscopic effect of lamp flicker must be addressed in areas with rotating machinery (e.g., circular saws).

One of the important parts of learning is colour appreciation. For this reason it is essential to use electric light sources that present colour perfectly (especially in art and design rooms). Providing good colour is not now very expensive to reach. Therefore, lamps with a CIE colour-rendering index of not less than 80 are recommended. With respect to colour appearance, lamps with a warm to intermediate classification (Correlated colour temperature 2527oc-3727oc) should be used. Switching arrangements should facilitate shared use of spaces where suitable [16].

It is important to control the glare from overhead lighting especially for visually impaired pupils. For fluorescent lamps, high frequency electronic ballasts are more preferred since they avoid subliminal flicker. Also, they can prevent the demonstration of annoying visible flicker that can happen with conventionally ballasted lamps at the end of their life. If high frequency ballasts are used, attention should be given to the use of a regulated version, which can be darkened to allow the adjustment of the illuminance level in order to suit the individual as well as to save energy. Usually, the additional cost is modest. It is not economic to install more than the recommended illuminance on the off chance that they will be useful some day to a hypothetical visually impaired pupil. Additional illuminance can be reading supplied when the need arises from local task lighting luminaries.

4.4. Combined Daylighting and Electric Lighting

When the daylighting recommendations cannot be obtained throughout a space a particularly designed supplement of electric lighting should be provided. In addition to providing a combined illuminance for activities being undertaken, a suitable appearance should be achieved by a balance of brightness throughout the space to cope with relatively bright windows. Preferential lighting and especially wall lighting in areas far from the window can obtain this.

4.5. Lighting Quantity

It is stated by the Department of Education and Science that the lowest level of illumination on a working plane at any point should not be less than 150 lumens and where fluorescent lighting is used it should not be less than 300 lumens [13]. In spaces, where combined lighting is needed (such as laboratory) illumination should not be less than 200 lumens (Ibid). The level of illumination for each space in the school is shown in the table9.

4.6. Lighting Quality

Lighting is divided in two types: natural and artificial. In schools, daylight should be the main source in working areas. Artificial lighting is needed to supplement daylight occasionally on the dullest days, in darkness or at night. In teaching areas, the level of maintained illumination and daylight factor should not be less than 108 lumens per square meter and 2% respectively [1]. The 2% daylight factor could be obtained with a glazed area of 15 to 20% of the floor area. The main problems are glare and overheating, caused by the presence of the sun. Appropriate solutions should be taken at an early stage of design.

4.7. Emergency Lighting

The aim of emergency lighting is to produce sufficient illumination, in the event of a failure of the electricity supply to the normal electric lighting, in order to be able to evacuate the building quickly and safely and to control processes and etc., securely.

Emergency lighting in school buildings is provided only in areas where the general public has access in the evenings. Halls and drama spaces are also included. Emergency lighting is not usually provided on escape routes, except from public areas, since the children are familiar with the buildings and there is only a small part of the school year in the hours of darkness. Emergency lighting should be considered in upstairs escape corridors; escape stairways, corridors without windows and areas with dangerous machinery. It is advised that the emergency lighting should be the maintained type for halls, gymnasium and other areas used by the public during the hours of darkness. Where part of the premises is licensed it will be essential to follow the guidance of the Local Fire Authority.

Emergency Lighting should make visible safe passageways out of the building, the fire alarm call points, the fire fighting equipment, escape signs and any changes of direction or stairs [2].

4.8. Lighting for Pupils with Visual and Hearing Impairments

Lighting and acoustic criteria are critical both to the hearing impaired and the visually impaired. The design of particular accommodation for the visually impaired is beyond the scope of this research but specialist advice can be obtained from the Royal National Institute for the Building. (RNIB/GBDA Joint Mobility and the Partially Sighted Society, London), however, design choices should be considered for all schools. Many of the low cost or no cost procedures can be applied to existing buildings such as tactile surfaces and types of luminaries.

Other means, such as providing or facilitating the use of visual aids can be examined as necessary. A general guide is given in the following part that can be helpful in the majority of cases. Visual impairment is composed of two main conditions:

1) *Field Defects*: In this condition, what is seen is clear but the visual field is restricted. In some cases only the central part of the field is seen (tunnel vision). Therefore, mobility would be impaired. However, in these cases the ability of reading and doing fine work would be largely unaffected [2]. Conversely, in other cases there is a loss of central vision. This means that movements can be performed in safety but the ability of performing detailed tasks (such as reading or sewing) would be very difficult and sometimes impossible. In all types of field defect the amount of task illumination is not important supposing that normal advices are followed.

2) *Loss of Acuity (blurring of vision)*: The extent of the blurring is widely variable. Some pupils need to bring objects very close to their eyes to see well. It may also be associated with loss of colour vision.

Depending on the cause of the loss of acuity, higher illuminance and large print can be helpful. Many schools now can produce their own reading material and the use of a sans serif font of at least 14 point size can be a useful aid. Glare should be avoided because it can aggravate the effects of low acuity. A 'white' board on a dark coloured wall can be a source of glare whereas a traditional "blackboard" would not. Also, a view of a daylight scene through a window is another source of glare [2].

Loss of visual field and acuity can coexist. Also, the special problems experienced by people suffering from visual

impairment and their responses to light and other environmental features are very variable.

The usage of higher task illuminance is helpful to those whose acuity can be improved by the contraction of the iris, resulting in a greater depth of field. However, in some patients, such as those with central cornea opacities, the iris has to be dilated with the aim that the pupil can see around the opacity. In this condition, more light not only will not improve the difficulty but also will aggravate the problem.

4.9. Positioning

The position of visually impaired pupil should be located where they can best see the work. This may be a seat outside the normal arrangement, such as immediately in front of the board or the teacher.

Also, it is important that any visual aids are available for usage. These can include a wide range from hand-held or stand mounted optical magnifiers to CCTV magnifiers. Local task lighting can also be useful. In order to have access to an electrical supply, cope with excess daylight or use any other aid, it may be necessary to allow the student to change position and move within the teaching space.

4.10. Use of Colour

Colour and contrast are especially important to the people with visual and hearing impairments. For example down lighters in reception or teaching areas provoke harsh shadows, which limit lip-reading. Colour should be used carefully in order to assist pupils in the identification of a place. It may be more necessary than an elaborate lighting installation.

In some visually impaired cases there is some degree of colour blindness and it is of great importance that contrast should be introduced in luminance and not only colours. For example, pale green and pale cream may be clearly distinguished by the normally sighted pupils but be seen as a single shade of grey by some pupils with visual impairment. In order to aid orientation within a space, contrast should be used in the décor. For example, using a darker colour for the architrave around a door will help to identify the location of the door and a handle, which clearly contrasts with the surface of the door, will show which way it swings. In some spaces orientation may be introduced by the furniture arrangement or by windows during daylight hours. In others it can be established by making one wall distinctly different (for example by adding a large clock or changing the colour. Whatever method is used, it is best adhered to throughout the building, i.e., the different wall is always to the same side of the main exit from the space [17].

Surfaces finished with high gloss should be used carefully since they can reflect bright lights such as sunlight. Generally, eggshell finishes are to be preferred because some directional reflection is desirable rather than dead matt surfaces, which may be difficult to place precisely. Also, changing the tactile qualities of surfaces can be helpful to reinforce visual contrasts. In school buildings they are most important for the blind.

5. Design of Shading Devices

In climatic consideration, shading has great importance. Although the external openings should be decreased as much as possible together with providing good view and light, they should be shaded as well. Generally, there are two types of shading devices, i.e. internal and external shading devices. External shading devices are most suitable for the type of climate in central and south of Iran (i.e. Yazd, Boshehr, Bandar-abbas, Kerman, etc.). Internal shading devices will be appropriate for other type of climate. They release the radiation absorbed to the interior and as glass prevent long wave radiation from escaping. This will create overheating problems [7]. Then, the solution for the climate of central and south is external shading devices. There are two types of external shading devices, depending on the altitude of the sun and the orientation of the façade, which needs to be shaded. These two categories are horizontal and vertical shading devices (Ibid).

5.1. Determination of Shading Devices

The determination of under heated and overheated periods of the year could make possible the design of shading devices [8]. For this purpose, the temperature- shading chart has been prepared. The comfort zone for schools in the considered region varies from 20 to 24°C [9]. The shading chart has been obtained by the method described by Martin Evans [18]. The curved lines on the chart have been obtained by joining the equal temperatures at different periods. The overheated period has been located approximately between the 15th of June to the 30th of September between 10 am and 6 pm. The under heated period has been located from the 15th of November to the 30th of March. The overheated period has been repeated on the corresponding sun-path, latitude 32° north. By using a shadow angle protector several shadow angles have been determined for the following orientations: east (north-south axis), south-east (35° from the east-west axis), south (east-west axis), south-west (35° from the east-west axis), west (north-south axis) and north-west (35° from the south-north) (see table 3).

For economical and practical reasons the following notes are suggested:

a) For east, west and near these orientations, a vertical shadow angle of 60° is a compromise solution (this means an overhang of 60 to 80 cm).

b) For the horizontal shadow angle a compromise solution is an angle of 60°. This means vertical louvres of 30 cm (figure 2).

Table 3. Vertical and Horizontal Shadow Angles in Degrees [10]

Orientation	Vertical Shadow		Horizontal Shadow	
	Angle in deg		Angle in Deg	
	a	b	a	b
East	70	80	30&60	60&75
South-east	65	70	0&45	0&55
South	60	70	-45&80	-50&85
South-west	50	70	0&45	-40&20
West	50	70	-35&-05	-60&-30
Nourth-west	35	60	-50&-30	-65&-45

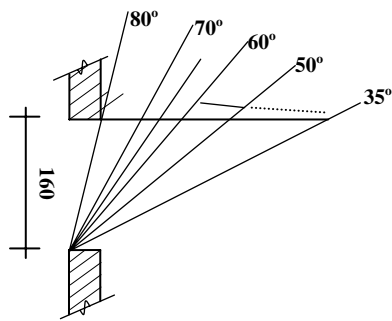

A compromise solution for vertical shadow angle is an angle of 60° this means an overhang of about 60 to 80 cm.

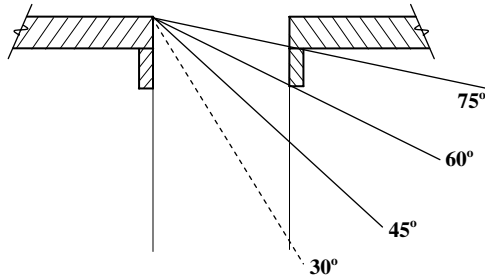

A compromise solution for horizontal shadow angle is an angle of 60° this means a vertical louver of about 30 cm.

Fig. 2. Horizontal and Vertical Shading Device (Designed by Authors)

5.2. Economy of Shading Devices

Economy of shading devices can be provided if:

- A compromise solution not exceeding two types of shading devices is found.
- External openings are kept at their minimum; this limits the quantity of shading devices.
- Parts of the building can be designed for shading as well. For horizontal shading devices, it is possible to project the roof to obtain an overhang. For the vertical shading devices, it is possible to shape the external elevation to produce vertical louvers.
- Shading devices can act as a radiator in cold periods and brings heat during hot periods. Olgay suggests that the shading device should be connected at necessary points only [20].

5.3. Shading Effect of Trees and Vegetation

The microclimate of buildings is influenced to a large scale by trees. Olgay explains in his book called "Design with climate" that:

"...Trees contribute much to the immediate physical environment. They reduce air borne sounds with great efficiency if densely planted. The viscous surface of leaves catches dust and filters the air. Vegetation can also secure visual privacy and reduce annoying effects" [20]. Trees contribute also in the reduction of heat loss from building during winter and the absorption of radiation in summer. Their selection should then be subject to their shading performance and their position to different orientations.

6. Daylight Quantity calculation

Daylight can be handled quantitatively in two ways:

- By using luminous quantities (flux, illuminance), i.e., by a set of outdoor conditions and calculating the resulting interior illuminances;
- By using relative values (the daylight factor) which compare indoor to outdoor illuminance. For a given position, this factor is constant under widely varying outdoor lighting conditions.

The illuminance provided by the daylight can be determined from the following algorithm by the definition of daylight factor (*DF*) [2]:

$$L_{ui} = L_{ue} * (DF/100) * Of \quad \text{Algorithm 1}$$

Where: *L_{ui}* is interior illuminance (lux), *L_{ue}* is exterior illuminance (lux) and *Of* orientation factor.

6.1. Exterior Illuminance

For calculation of exterior illuminance we need to know about luminous efficacy of solar radiation. The luminous efficacy of solar radiation is defined as the ratio between illuminance and irradiance. Thus, if irradiance measurements or calculations are available it is possible to estimate illuminance values using a luminous efficiency [21]. The luminous efficiency of energy-radiation depends on its spectral composition; there is no constant relationship between radiation intensity and its lighting effect or illuminance. However, as a general guidance, the value of 100 lumens/watt can be used for solar radiation. This would give an illumination of 100 lux for every W/m² intensity or 100 000 lux per kw/m² [8], [6] and Dr. N Baker, Martin Centre, Cambridge University, private communication. As discussed before, the amount of solar radiation can be calculated for different cities in Iran by using the designed excel sheet programme. Also using the following formula can perform the estimation of hourly or monthly illuminance value:

$$\text{Solar radiation (W/m}^2\text{)} * 100 \text{ lumens/watt} = \text{Illuminance (Lux)} \quad \text{Algorithm 2}$$

Three cities of Iran located in different climate have been selected and their average exterior illuminances are illustrated in tables 4 -6.

6.2. Orientation Factor

The reason for the introduction of window orientation factor is that even with overcast skies, there is a considerable variation in luminance (the southern sky having the greatest effect). Orientation factors for calculation of interior illuminance are, 0.97 in northern, 1.15 in eastern, 1.21 in western and 1.55 in southern windows [2].

6.3. Daylight Factor

The daylight factor (*DF*) is a very common and easy to use measure for the subjective daylight quality in a room. It

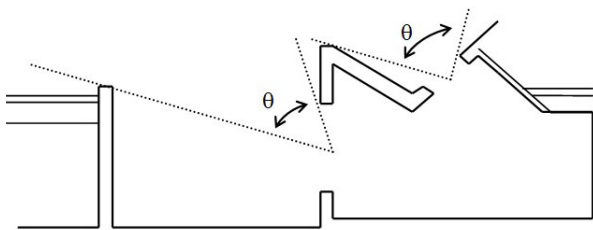

Fig. 3. Angle of q , which defines visible sky from centre of window/rooflight

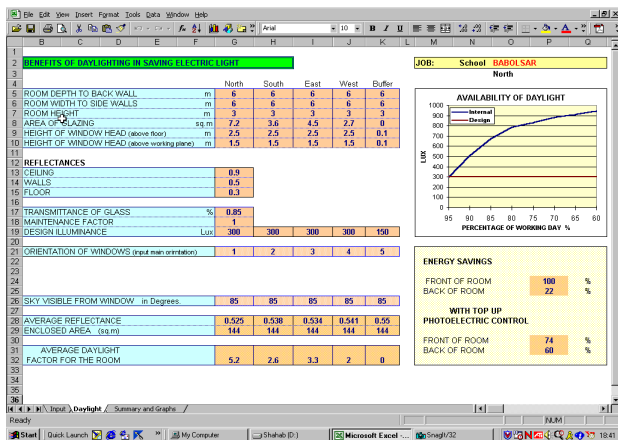

Fig. 4. The calculation page of the daylighting analysis programme

7. The Admittance Procedure

The programme used in this research has been developed from the Admittance procedure given in the Chartered Institute of Building Services, Guide Book A - Section A6 [22]. This procedure was developed to give a prediction method for dynamic thermal performance. It takes into account:

- The daily cycle in temperature
- The modifying effect of the thermal mass of the building materials on temperature fluctuations
- Solar heat gains
- Variations in ventilation and internal gains

The model works by firstly estimating the mean energy flow across the structure and then adding or subtracting flows, which would be expected at specific time intervals (one hour). It assumes that the daily cycle in temperature and energy flows is cyclic.

Modification factors are applied to the flows to ensure that the model takes into account thermal storage and the re-admission of heat from the internal surfaces to the room/building. These factors explained before. An illustration of the type of curve, which would be expected from the use of the Admittance procedure refer to CIBSE [22].

In this programme, one of the factors taken into consideration is lighting loads for each hour of the day (for each month).

7.1. The Equations Used Within the Excel Programme

The equations used in the admittance procedure (for lighting section) are set out below:

- Mean Solar Gain

$$Q'_s = S I' A_g$$

Algorithm 6

Where: Q'_s is mean solar gain (Watt), I' is mean solar intensity (W/m^2), S is solar gain factor and A_g is sunlit area of glazing (square meter).

- Swing in Solar gain

$$Q''_s = S_a A_g (I_p - I')$$

Algorithm 7

Where: Q''_s is swing in effective heat gain due to solar radiation (Watt), S_a is glass blind correction factor and I_p is peak intensity of solar radiation (W/m^2).

7.2. Glass Blind Correction Factors

If in the glazing system there exists blinds then these will have an effect of the transmission of solar energy into the space and therefore within the CIBSE procedure are given a range of correction factors into account. The factors are shown in table 8.

- Decrement Factor

The decrement factor is the ratio of the rate of heat flow through a structure to the internal space temperature for each degree of swing in external temperature about its mean value, to the steady state rate of heat flow or U value. It is the attenuation of a wave travelling through an element of the building structure. For thin surfaces of low thermal capacity, the decrement factor could be taken as 1 but it decreases with increasing thickness and thermal capacity. An illustration of how the decrement varies with thickness and the degree of thermal insulation is shown [22].

- Time Lag

The time lag of a structure can be defined as the time it takes for an initial energy flux to travel across the structure. The higher the thermal mass the slower will be the rate of travel through the structure. Typically dense structures can have time

Table 8. Glass/ Blind correction factors [22]

Glazing/Blind configuration	Correction factor	
	Single glass	Double glass
None	0.76	0.64
No shading lightly heat absorbing glass	0.51	0.38
No shading densely heat absorbing glass	0.39	0.25
No shading lacquer coated	0.56	---
No shading heat reflecting	0.26	0.25
Internal shading open weave plastic	0.62	0.56
Internal white venetian blind	0.46	0.46
Internal white cotton curtain	0.41	0.40
Internal cream Holland linen	0.3	0.33
Mid- pane white venetian blind	---	0.28
External open weave plastic	0.22	0.17
External canvas roller blind	0.14	0.11
External white louvred sunbreaker	0.14	0.11
Dark miniature louvred blind	0.13	0.1

lags in excess of 9 hours which means that if a structure is exposed to an energy flux at say 10 noon it will be 9pm when that flux reaches the inside surface.

- Surface Factor

The surface factor is the ratio of the variation of heat flow about its mean value readmitted to a space from the surface, to the variation of heat flow about its mean value absorbed in the surface. The surface factor decreases and its time lag increases with increasing thermal capacity and they are almost constant with thickness. It is used when allowing for solar radiation and the radiative component of internal gains on internal surfaces. Values of surface factor are: Light=0.5, Medium=0.8 and Heavy=0.9.

7.3. Using the Monthly or Annual Admittance Programme

The programme used for the analysis of the energy performance of the school designs was developed within the school of Architecture for general research and building analysis. It is based on the Chartered Institute of Building Services Engineers Guide Book A [22].

In the departmental version the solar radiation values are imported from the solar prediction model Meteonorm as tables in an excel worksheet. These tables are then accessed by the calculation worksheet. The version used in this research is based on the departmental version but has been modified so as to be able to use the solar radiation data calculated by the routines outlined before. Other modifications included simplifying the input worksheets to either enable or disable heating or cooling and also to be able to specify to a greater extent the internal gains from people, lights and equipment. The input sheet was also re-written so as to give the necessary information for running the solar radiation model.

7.4. Operation of the Admittance Model

The programme takes the input data and carries out the following calculations to arrive at a result.

1. Firstly the solar radiation values are calculated according to the equations given before and then this information is used to calculate the following:
2. The Sol- Air temperature and then modify it for time lag
3. The mean energy flow across the structural elements, modified by time lag surface factor and decrement factor
4. The difference in the energy flow from the mean (on an hour by hour bases)
5. The energy transfer through the windows, modified by the Glass/Blind correction factor
6. Internal heat gains from occupancy and other loads such as lighting and equipment
7. Natural ventilation loads

All of the above loads are then added together to produce a total energy load for the month under consideration. The programme uses hourly data for each day of the year and therefore it is a simple matter of adding the daily loads to obtain monthly values.

7.5. Output

This lighting programme enables the calculation of the period of time during the school day in which adequate daylight is available and from this information it is then possible to establish how much electric lighting is required during periods when adequate daylight is not available (These values are shown in figure 5 and figure 6). This electrical energy requirement is then used in the main Excel spreadsheet as the input for artificial lighting requirement.

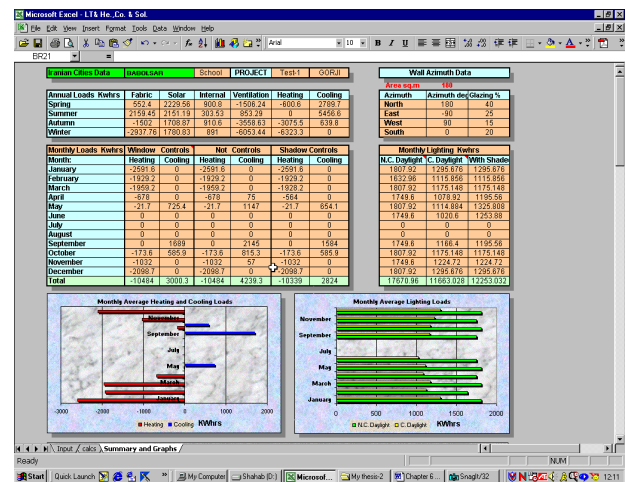

Fig. 5. The output page showing how the energy usage is given tabular and also in graphical form

8. Summary and conclusion

Solar energy is one of the most important renewable energy sources in the world. Solar radiation data are the best source of information that is related to solar energy besides other meteorological measurements. These data have not been calculated in Iran so far. Therefore, this research contains the method of calculation for solar radiation in different cities of Iran and a designed excel sheet program for Iran.

The current designs of school buildings in Iran are not energy efficient. One of the reasons for this could be the use of inappropriate glazing-ratios and the materials used in the construction of walls and roofs have little or no thermal insulation. One of the major problems of the developing countries such as Iran is the lack of knowledge about new technologies in using renewable energy. Therefore, the keys to improved building energy efficiency in the future are to learn and apply these efficient technologies. One of the simplest methods of doing this is to make use of solar energy as a supplement to the heating and lighting requirements of buildings.

The daylight factor of 1.5%, which is generally recognized as being a suitable level of illumination on the working plane, is based upon a temperate zone sky with an internal level of approximately 300 lux.

In this paper the assumption has been made that Iran has a mean sky value of 35 to 40 klux. The openings necessary to give the equivalent of a 1.5% daylight factor have been

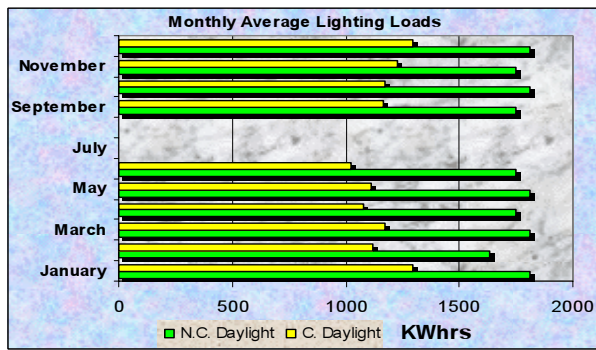

Fig. 6. Monthly average lighting loads

calculated on this basis. The point is emphasised that direct sun should not be allowed to penetrate into working rooms in order to reduce heat gain.

Priority should be given to daylight as the main source of light in working areas, except in special circumstances. Wherever possible a daylit space should have an average daylight factor of 4-5%.

Teaching spaces should have views out except in special circumstances. A minimum glazed area of 20% of the internal elevation of the exterior wall is recommended to provide adequate views out.

A maintained illuminance at floor level in the range 80-120 lux is recommended for stairs and corridors. Entrance halls, lobbies and waiting rooms require a higher illuminance in the range 175-250 lux on the appropriate plane.

Each room or other space in a school building shall have lighting appropriate to its normal use. The illuminance of teaching accommodation shall be not less than 300 lux on the working plane.

In teaching accommodation where visually demanding tasks are carried out (like painting room), provision shall be made for a task illuminance of not less than 500 lux on the working plane, for more recommended illuminance values for school building (see table 9), which has been brought together from sources in Iran and UK:

References

- [1] Department of Education and Science (DES), (1967) and (1981), Lighting in Schools, Building Bulletin N. 33, HMSO.
- [2] DFEE, (1999) and (1993), Lighting Design for Schools, Building Bulletin 90, Department for Education and Employment, London.
- [3] BRE. Information (1996), People and Lighting Controls, Paper IP6/96.
- [4] HMSO, (1995), Approved Document (Conservation of Fuel and Power) in Support of the Building Regulations, Department of Environmental and Welsh Office Section 2.4.2 Lighting.
- [5] Martinot, E., Borg, N. (1998), Energy-efficient lighting programs, Experience and lessons from eight countries. Energy

Table. 9. Recommended illuminance value for school building in Iran, [9] and [2]

Place	Minimum /lux	Maximum /lux
Classrooms and Lecture Theatre	300	500
Painting and Hand works room	500	700
Blackboard (Vertical surfaces)	300	500
Reception areas	250	350
Laboratory	200	500
Gymnasium	150	300
Entrance hall, Lobbies and waiting rooms.	175	250
Stairs and corridors (Circulation spaces)	80	120
Changing room, Toilet and lavatory	50	100

- [6] Marks, (1993), Lighting Handbook, Illuminating Engineering Society of North America, New York.
- [7] Givoni. B. (1981), Man, Climate and Architecture, 1981, Applied Science Publishers Ltd.
- [8] Koenigsberger, O.H. et al. (1993), Manual of Tropical Housing and Building, Part One Climatic Design. Longman Group Ltd, London.
- [9] Research Centre, (1992), Lighting Standard, Iranian Building Code, Ministry of Building and Urban Design, Tehran Iran, Vol 19, Lighting.
- [10] <http://en.wikipedia.org/wiki/Sunlight>
- [11] Tsangrassoulis, A., Santamouris, M., Asimakopoulos, D.N. (1996). Theoretical and experimental analysis of daylight performance for various shading systems. Energy and Buildings 24. Elsevier.
- [12] British Standard, (1992), Lighting of Buildings, Part 2 Code of Practice for Daylighting. British Standard BS 8206:Pt2, 1992.
- [13] Department of Education and Science (DES), (1977), Energy Conservation in Educational Buildings, Building Bulletin No.55, HMSO, p.9.
- [14] Konya, Allan (1980), Design Primer for Hot Climate, Architectural Press: London, Whitney Library of Design and Inprint of Wastson, Guptill Publications New York, p.36.
- [15] Boyce P.R. (1973), Age, Illuminance, Visual Performance and Preference, Lighting Research and Technology, Vol. 5, No3, 1973.
- [16] CIBSE, (1985), Technical Memorandum 10, The Calculation of Glare Indices.
- [17] Architects and Building Branch Department Education and Employment, (1997), Guidelines for Environmental Design in Schools, Building Bulletin No., 87, London.
- [18] Evans, Martin (1980), Man Climate and Housing, 1980, The Architectural Press, London.
- [19] Aiche, Massaoud (1987), The Improvement of School Building Design in Rural Areas in Algeria, School of Architecture, M.Phil, Research, No. 26.
- [20] Olgyay, Victor (1963), Design With Climate, Bioclimatic Approach to Architectural Regionalism, Princeton University Press.
- [21] Robledo, L. and Soler, A. (2001), On the Luminous Efficacy of Diffuse Solar Radiation. Energy Convers Manag 2001: 42:1181-90.
- [22] CIBSE, (1986), Design Data, Guide Book A, Section A6, 5th Edition. London, Chartered Institution of Building Services Engineers.