

Research Paper

The effect of window configuration on daylight performance in classrooms: A field and simulation study

Z.S. Zomorodian¹, S.S. Korsavi², M. Tahsildoost^{3,*}

¹PhD researcher, Department of Architecture, Shahid Beheshti University, Tehran, Iran

²Master of Architecture, Department of Architecture, Shiraz University, Iran

³Assistant Professor, Department of Building Construction, Shahid Beheshti University, Tehran

Received: 22 June 2015, Revised: 13 October 2015, Accepted: 24 November 2015, Available online: 29 June 2016

Abstract

Daylight in classrooms is a critical factor in school design, in terms of its impact on students' health, learning and visual performance. Providing adequate amount of evenly distributed daylight and glare prevention are important challenges in classroom design. Window configuration significantly affects the intensity and uniformity of daylight. This paper aims to investigate the effect of window configuration on daylight performance through parametric analysis. Different window configurations such as window to wall ratio, incorporating light shelves and roof monitors have been analyzed on a typical south-east facing classroom in Kashan based on results from DesignBuilder Radiance simulation which has first been validated against field measurements. Daylighting credits of green building rating tools; Leed EQ 8.1 and BREEAM HEA1 have been used as indices for evaluating and comparing different window configurations. Results show that by increasing the window-wall-ratio to 35, 40 and 50% and by installing a roof monitor, the daylight credits of the BREEAM and LEED could be achieved respectively. According to the fact that none of these window configurations have reached the standards required by both rating tools, the authors believe that a combination of installing monitor roof and light shelves and increasing window-wall-ratio may result in enhanced daylight levels.

Keywords: Daylight performance, Window configuration, Classroom, Daylight metrics, Daylight credits.

1. INTRODUCTION

Daylighting as a visual sensory element of physical interior environments [1] is a predominantly critical issue in school design. Since reading and writing are the most important tasks that take place in schools, visual performance is considered the main outcome for lighting design [2] and is defined in terms of speed and accuracy of processing visual information [3,4]. Moreover, daylight can influence reading, task involvement, productivity [5, 6], sense of wellbeing, mood and health, comfort, perceptions of space, emotions, students' experiences and behaviors [1] and therefore is a critical factor in school design. The objective of this paper is to firstly introduce different window configurations for daylighting in classrooms and useful daylight metrics through literature survey and secondly, to evaluate daylight performance of different window configurations using green building rating tools. To achieve the aims mentioned above, parametric analysis has been done using DesignBuilder Radiance daylighting simulation engine.

The main goal is to adopt strategies which would enhance daylight performance without increasing construction and operation costs in schools.

2. METHODOLOGY

The research methodology conducted in this study includes three steps: literature review, software validation and parametric analysis. First, different configurations of windows, common static daylight metrics and daylighting credits of green building rating tools have been discussed through literature review to evaluate daylight performance. Second, the appropriate software for the objectives of the study has been selected and validated against experimental data prior to parametric analysis. Third, simulations were run to find out how daylight performance within a space changes as a function of the window configurations. Indeed, the authors have simulated different window configurations to compare and assess daylight performance through daylight metrics and green building rating tools.

2.1. Literature Review

2.1.1. Window configurations

* Corresponding author: M_Tahsildoost@Sbu.ac.ir
Tel: +989121395045; Fax number: +9822431630

The design of openings becomes much more complex in climates with clear and sunny sky. Configuration of openings can modify the intensity and distribution of daylight to create appropriate luminous environments [3, 7-10]. The configuration of windows is dealt with in greater detail in the following.

- Sidelighting; although the most common way to introduce daylight into a space is via side openings, a critical issue in side lit spaces with a single aspect, common in classrooms, is the fact that daylight contributions are not uniform, falling off rapidly as one moves away from the opening [3].
- *Window location*; the intensity and distribution of daylight improves with higher glazing positions [3, 11, 12].
- *Window to wall ratio (WWR)*; the daylight distribution is also affected by greater areas of openings, extending daylight zone [3, 11, 12].

Another paper has studied the effect of window size on sunlight presence and glare in a private office room of a typical size [13], showing that perceived glare rises from 1.4 to 4.7 as the window area increases from 20% to 50% of the wall area, and then decreases as the window size increases beyond 50%. The International Building Code and British Standard BS 8206 have also recommended minimum window areas, with the former requiring minimum net glazed area not less than 8% of the floor area of the room and the latter recommending minimum window area of 20% of the external window wall for a room measuring less than 8m in depth and 35% of the external wall for rooms deeper than 14 m. In a study done for an office room in Iran, the most appropriate options for WWR (window wall ratio) are 30%, 35% and 40% [10]. The amount of daylight has also been assessed in north and south facing rooms in Turin, north-west Italy with different window size, concluding that 40% WWR is sufficient to guarantee 'useful' daylighting [14]. An interesting article has assessed the variation of daylight factors depending on the shape, size and position of the opening [15].

- *Window glazing*; the importance of window glazing on energy and daylighting performance of buildings and various optimization techniques in choosing window glazing has been studied in this paper [14, 16].
- *Lightshelves*; another strategy to maximize daylight distribution is to incorporate light-shelves to bounce daylight back into the interior [11] while protecting the front part of the room from harmful visual effects of direct sunlight [3, 17].
- *Rooflighting and clerestories*; apertures of day lighting are not only side lighting windows but also skylights and clerestory windows which allow daylight to penetrate deeper into the space [3].

Roof monitors and light shelves are the most appropriate daylighting strategies in schools [9]. These strategies have been evaluated through simulations [18, 19] and field studies [20, 21] in classrooms. According to Guide for Daylighting Schools [22], roof monitors that include vertical south-facing glazing, interior baffles and overhangs with proper size have many advantages; they

create uniform lighting throughout the space, heat the space passively by allowing more radiation to enter the space in the colder months; provide filtered and diffuse lighting and eliminate contrast and glare. Nevertheless, the biggest problem of roof monitors is that they can only be applied in single story buildings or in the last floors of buildings. Although south-facing lightshelves have some weaknesses, they are the next best solution since they are less expensive than monitors, they shade view glasses which are located below them and easily bounce daylight to the back of the classrooms [22]. Using lightshelves, achieving uniformity becomes difficult since the all of the light comes from one side of the classroom. In rooms more than 6 meters deep, there is a significant decline in light levels, which causes contrast between the brighter glazed wall and the opposite side of the room. According to Guide for Daylighting Schools [22], appropriate amount of glazing is 8%-11% of the classroom floor space in order to have enough amount of daylight for both strategies.

2.1.2. Daylight metrics

Over the past decade, many metrics have evolved for measuring daylight, which can be categorized into two main groups: static metrics and dynamic metrics. Static metrics (moment-in-time based metrics) include daylight factor, view to the outside, the avoidance of direct sunlight [23], uniformity, and illuminance [24] while dynamic metrics include daylight autonomy (DA), continuous daylight autonomy (cAD), useful daylight index (UDI), spatial daylight autonomy (sDA) and annual sunlight exposure (ASE). The main difference between dynamic metrics and static metrics is that they consider meteorological data, the quantity of daylight and daily and seasonal variations of daylight throughout the whole year for a given building [25]. Among all static metrics, outside view through window could only be assessed through subjective measurements and questionnaires, while avoidance of direct sunlight can be analyzed by both subjective assessment and dynamic metrics. As we rely on measurement and simulation with static metrics, only daylight factor, uniformity, and illuminance could be applied in this study, which is discussed in the following.

1. *Daylight factor (DF%)*: DF is the simplest and the most common metric to quantify the daylight allowed by a window, as it expresses the potential illuminance inside a room in the worst possible scenario under overcast sky conditions, when there is less exterior daylight [16]. Although daylight factor is entirely independent of orientation, time of day and climate, its calculation simplicity makes it the most widely accepted daylight metric as the predictions are easy to communicate within a design team [26]. Daylight factor supporters argue that the overcast sky is the worst case sky condition and therefore any other sky will lead to more daylight in the space. According to Norwegian Green Building Council and BRE Global "The average daylight factor is the average indoor illuminance (from daylight) on the working plane within a room, expressed as a percentage of the

simultaneous outdoor illuminance on a horizontal plane under an unobstructed International Commission on Illumination (CIE) Standard Overcast Sky” [27]. Minimum and average daylight factor for classrooms have been defined as 2% and 5%, respectively [3].

2. *Illuminance*: is the amount of light falling on a surface per unit area, measured in lux [27]. Othman et al and Balocco et al [6, 28-30] have recommended average values of 750, 500, 500 and 300-600 and lux for visual tasks in classrooms, including reading and writing respectively.
3. *Uniformity*: which is defined as the ratio of the minimum daylight factor to the average daylight factor within the space [27, 31] creates a uniform distribution of illuminance and luminance [32]. Many lighting standards require a uniformity ratio of 0.8 (minimum/average) or 0.7 (minimum/maximum).

2.1.3. Credits of green building rating tools

Credits of green building rating tools, such as LEED and BREEAM, clearly illustrate whether daylight performance of each configuration reaches the required amount of each metric or not. These credits are applied to assess overall daylight quality.

1. *LEED NC-v.2.2 EQ 8.1*: requirement for LEED 2.2 EQ addresses a minimum daylight illumination of 25 foot candles to be achieved in at least 75% of all regularly occupied areas [33].
2. *BREEAM HEA1*: The BREEAM Health and Wellbeing Credit, HEA1, pass requires that both the following conditions are met:
 1. For pre-schools, schools and further education colleges, at least 80% of floor area in occupied spaces should be day lit, having an average daylight factor of 2.25 at the height of 0.8 meters for a multi-story building in a city with latitude less than 40.
 2. A uniformity ratio of at least 0.4 (spaces with glazed roofs, such as atria, must achieve a uniformity ratio of at least 0.7 or a minimum point daylight factor of at least 1.4%) [27].

2.2. Software Validation

For the purpose of this study, the DesignBuilder simulation software has been selected, which is able to plot daylight contours, average daylight factor and uniformity outputs for each zone, using the integrated radiance daylighting simulation engine. To ensure the accuracy of simulation results, they have first been validated against field studies.

2.2.1. Field measurements

A typical three floor school building in Kashan, Iran (33° 58' 59" N / 51° 25' 56" E) has been selected as the base model. Kashan is one of the cities of Iran with clear-sky conditions and good daylighting potential due to its

low latitude and geographical condition. Based on the meteorological statistics, reported by Kashan Weather Station, the sky of Kashan is 67% clear, 23% partly-cloudy and 10% cloudy during a year [34].

The school is oriented toward north-west and south-east with classrooms lined up on both sides of a central corridor. A south-east classroom in the second floor was selected for modeling and measurements (Fig. 1 and 2). 30% of the classroom’s side wall area is covered with two windows to provide natural daylight. The floor plan and section of the class are presented in Fig. 3 & 4.



Fig. 1 Top view of the school building



Fig. 2 Right, base Case classroom

Measurements were carried out on a sunny day (May 6, 2014). The illuminance levels were measured by ST-1301 Light meter (accuracy: $\pm 5\% \pm 10d$ ($< 10,000$ Lux/ft)) in 16 points (1.2 m*1.5m grid) on the table surfaces (0.75 meter) every hour from 8:00 am to 01:00 pm. To achieve more reliable results, the lights were turned off and the curtains were drawn back.

2.2.2. Base Case modeling

The classroom has been modeled with approximate resemblance to real conditions. The surfaces optical properties are presented in Table 1.

Table 1 Model optical surface properties

Building element	Surface optical properties
Window	Double glazing, 0.78 light transmission
Ceiling	85% reflectance
Internal wall	75% reflectance
Floor	60% reflectance
External Wall	45% reflectance
External ground	Asphalt, 7% reflectance

2.3. Parametric analysis

The parametric analysis has been done under CIE over cast day (10000 Lux) at the height of 0.75 meter (desk plane) along the central axis of the space. By changing

window configurations studied in the literature review, different models have been created. Despite the importance of glazing type in windows' daylight performance, the common glass type in local construction has been modeled in this study. In addition, the authors were able to create three models by adding light shelves with or without clerestory and roof monitor with vertical glazing to the base case model (Fig. 5 & 6). The dimension and location of the roof monitor and light shelves are based on design guidelines [22, 35] (Table 2). Daylight metrics including Daylight factor, Illuminance, and Uniformity have been calculated for each model. In addition, the eligibility for daylighting credits (LEED IEQ 8.1 and BREEAM Hea 01) in each model has been provided.

Table 2 Simulation variables

Design variables	Base case	Simulation range
Height of windows (m)	1.4 meter	1.0 m-2.4m
Window wall ratio (% of the wall)	30% of the wall	25%-50%
Window sill height (m)	1.2 meter	0.7m-1.2m
Light shelf	-	0.6 m depth
Roof monitor	-	9% glazing of the floor area

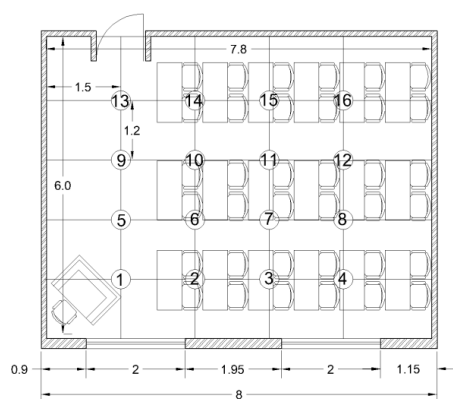

Fig. 3 Base case classroom floor plan

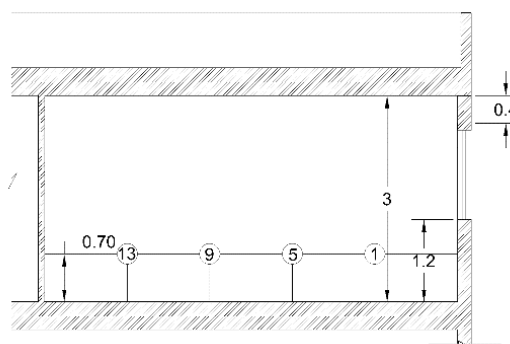

Fig. 4 Base case classroom section located in the 2nd floor

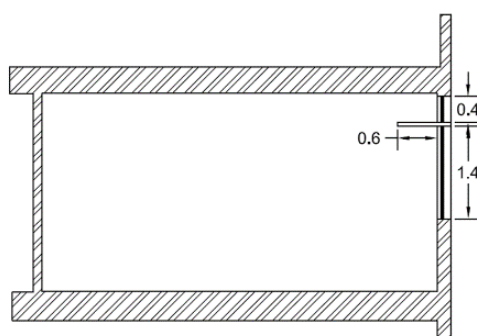

Fig. 5 Light shelf with clerestory model

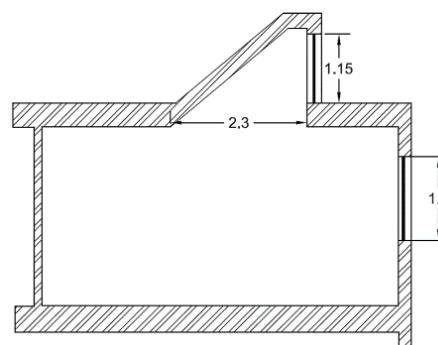

Fig. 6 Roof monitor model

3. RESULTS

3.1. Validation

The daylight map (illuminance level) under CIE sunny clear day sky condition from simulations is compared to the measurements taken every hour from 8:00 am to 01:00 pm. Comparison (Table 3 & Fig. 7) shows a Mean Bias Error (MBE) of 0.16, which is in the acceptable range of

±0.20, considered sufficient for most design purposes [36]. The MBE is calculated by equation 1, where N is the number of sensor points, Es is the simulated illuminance and Em is the measured illuminance [37].

$$MBE = \frac{1}{N} \sum_{k=1}^N \left(\frac{E_s - E_m}{E_m} \right) \quad (1)$$

Table 3 Measured and simulated illuminance levels in base case classroom at 10:00am

	point	1	2	3	4
near window	measured	1450	850	1005	1250
	simulated	1554	895	1115	1325
middle	point	5	6	7	8
	measured	765	650	680	715
	simulated	856	694	730	755
	point	9	10	11	12
back side	measured	360	450	460	375
	simulated	458	545	566	460
	point	13	14	15	16
	measured	210	300	320	285
	simulated	343	364	375	325

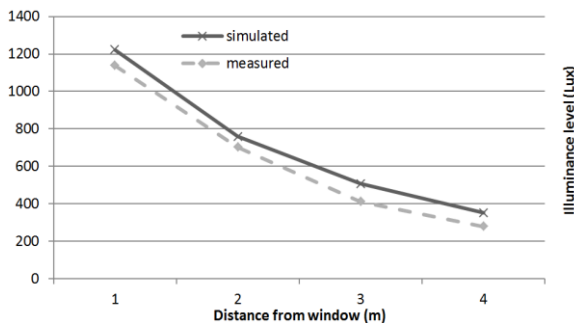

Fig. 7 Measured and simulated illuminance levels at 10:00 am May 6

3.2. Daylight metrics and window configurations

In the first step of the parametric analysis, the effect of window head height, windowsill height and window wall ratio on daylight intensity and distribution has been studied. Diagrams illustrate that by increasing window-head height from 1.4 to 2.4 m, the average and minimum daylight factor declined gradually. The highest level of average, minimum and maximum DF is acquired by windows with the height of 1.0, 1.4, and 1.8 m, respectively. Maximum DF is higher for higher windows in the walls. Generally speaking, the differences are quite insignificant especially when comparing the average DF (2.05-2.69) and minimum DF (0.51-0.61) for different window-head-heights (Fig. 8). Indeed, not only has increasing window-head-height improved the intensity of daylight, but also average and minimum DF have declined. By increasing window-head-height, uniformity (min/average) declines while uniformity (min/max) increases (Fig. 9).

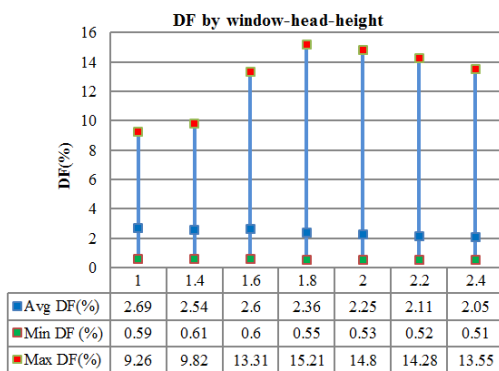

Fig. 8 DF by changing window-head-height

On the other hand, higher windows result in higher levels of maximum illuminance, which reaches its peak at the height of 1.8 m (Fig.10). Conversely, minimum illuminance declines by increasing window-head-height. It is interesting to note that windows with the height of 1.4 m (the height of base case) reach higher minimum DF, Uniformity ratio and minimum illuminance.

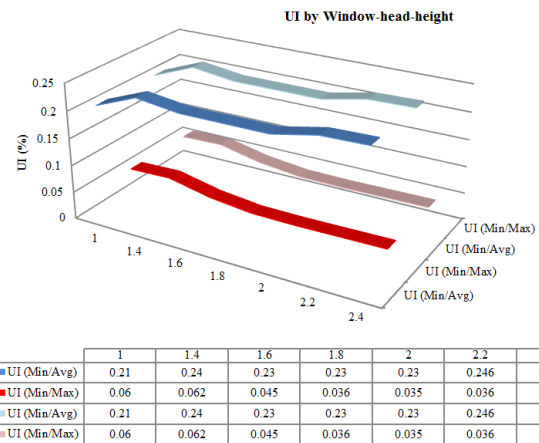

Fig. 9 Uniformity ratio by changing window-head –height

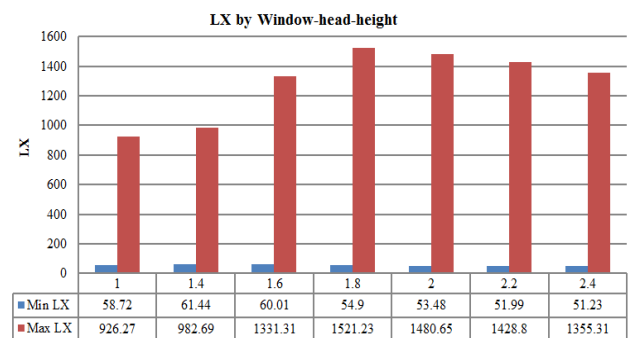

Fig. 10 Minimum and maximum illuminance levels by changing window-head –height

As shown in Fig. 11, minimum and average DF have gone into decline as the height of windowsill decreased from 1.2m to 0.7 m, while maximum DF increased with such a change to reach its peak at 0.8, and then declined modestly. By reducing the height of windowsill, uniformity and minimum illuminance have declined while maximum illuminance has increased considerably from 982.69 to 1502.26 lx (Fig. 12 & 13). Generally, reducing the height of

windowsill does not enhance the amount and uniformity of daylight. According to the fact that daylight metrics usually define minimum and average limits to meet the standards required, reducing the height of windowsill did not improve the daylighting condition in the 40 classroom. This finding

is in line with previous studies [3, 9, 11, 12, 38] demonstrating that higher windows distribute daylight more evenly since they let the light deeper into the space. Lower windowsill results in lower windows in the walls, reducing the uniformity and distribution.

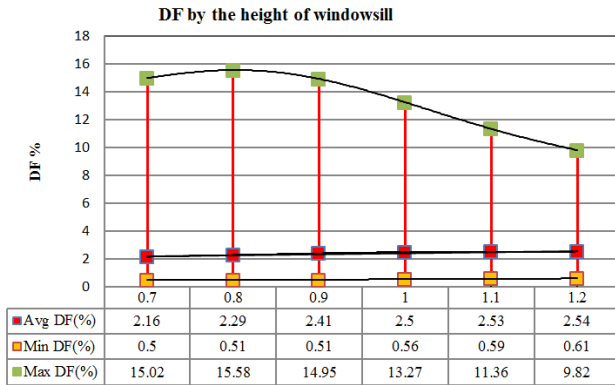

Fig. 11 DF by changing windowsill height

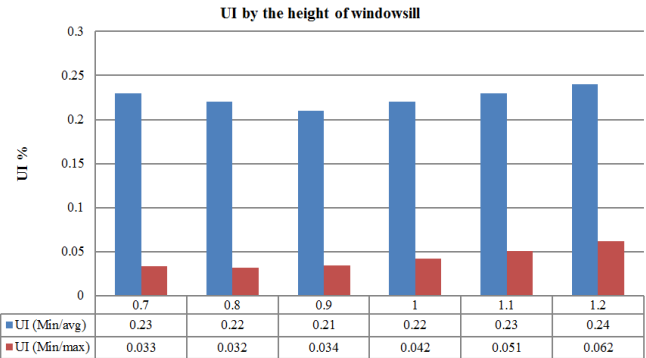

Fig. 12 Uniformity ratio by changing windowsill height

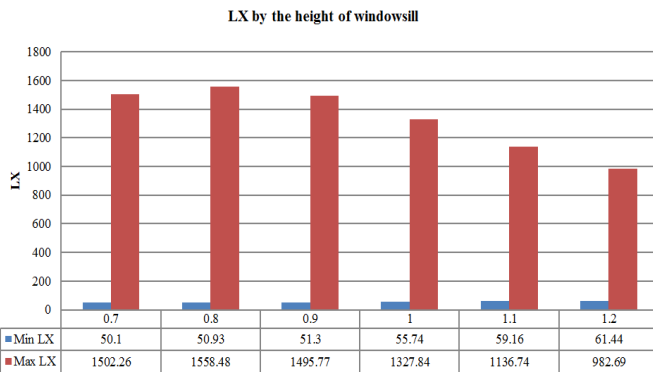

Fig. 13 Minimum and maximum illuminance levels by changing windowsill height

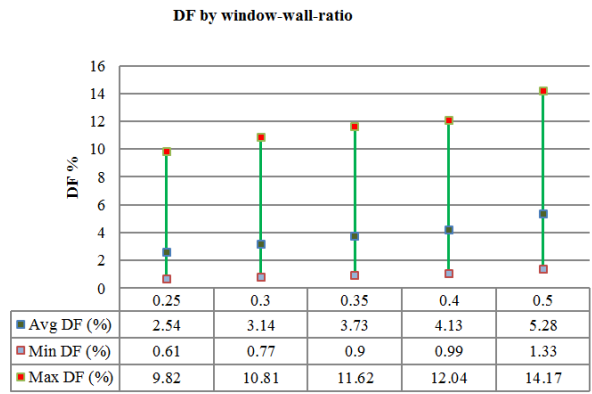

Fig. 14 DF by changing windowsill height

As shown in Fig. 14, 15, and 16, by increasing window-wall-ratio all daylight metrics show an upward trend, improving the intensity and uniformity of daylight

all over the place. This finding is in line with previous studies done by [3, 10-13].

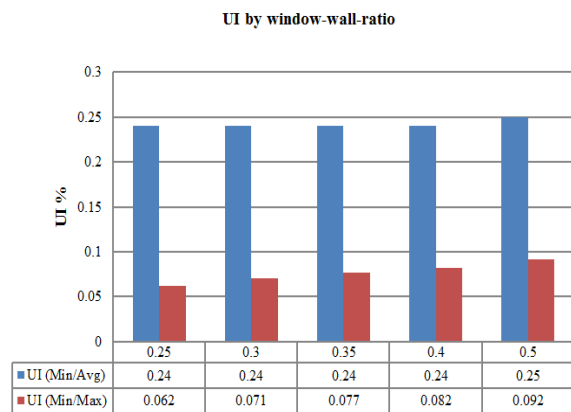

Fig. 15 Uniformity ratio by changing windowsill height

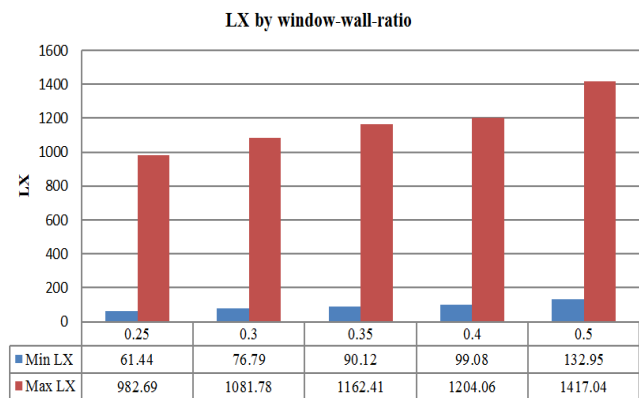

Fig. 16 Minimum and maximum illuminance levels by changing windowsill height

The second step of the parametric analysis examines incorporating a light-shelf into windows with clerestories and a roof monitor with vertical glazing. Results indicate that these strategies increase the level of average,

minimum and maximum DF especially in case of the installing roof monitor, where 63% increase in average daylight is achieved. This finding is in line with previous studies done by [3, 11]. Yet installing light shelf without

clerestories reduces the level of mentioned metrics (Fig. 17). Moreover, roof monitor increased the uniformity (min/max) ratio from 0.06 to 0.16, and the level of minimum illuminance in the classroom by 62%, while two other configurations do not make any significant changes

to these metrics, except for light shelves installed with clerestories which increase the maximum level of illuminance by 20% (Fig.18 & 19). According to the results, the roof monitor performed well in increasing intensity and uniformity of the daylight in the classroom.

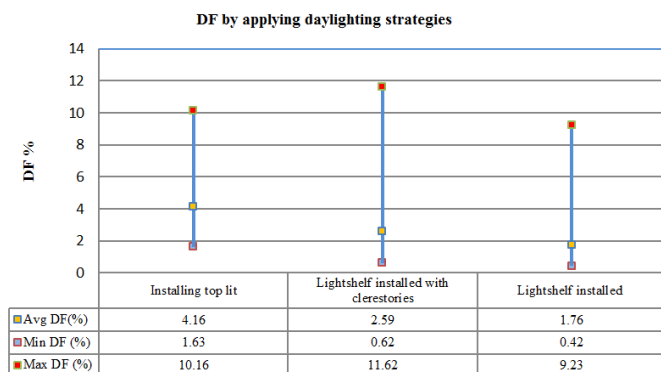

Fig. 17 DF by applying daylighting strategies

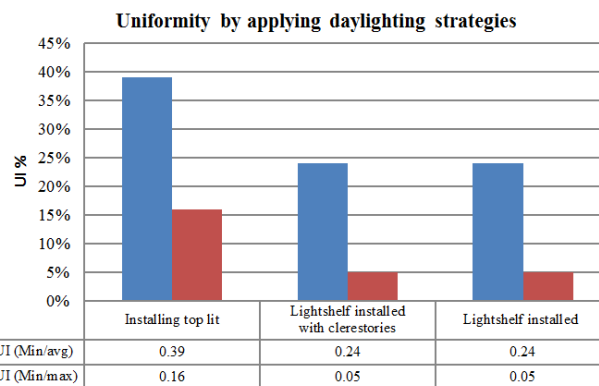

Fig. 18 Uniformity by applying daylighting strategies

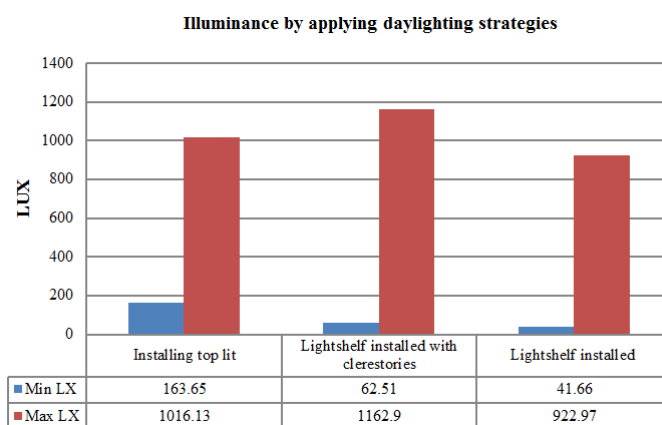

Fig. 19 Minimum and maximum illuminance levels by applying daylighting strategies

3.2. Daylight Performance through credits of green building rating tools

The aim of daylighting credits is to encourage and recognize designs that provide appropriate levels of daylight for building users. Thus, the third step of the analysis consists of evaluating different window configurations by daylight metrics in green building assessment tools. The eligibility for the LEED IEQ 8.1 and BREEAM Hea 01

credits has been provided by simulations and presented in Table 4.

It can be noticed that none of the configurations have succeeded in achieving the standards required by both of these credits. Increasing window-wall-ratio to 35, 40 and 50% has reached standards of BREEAM. Moreover, installing the roof monitor passes the requirements of the LEED credits.

Table 4 LEED IEQ 8.1 and BREEAM Hea 01 credits in different window configurations

Window configuration		Daylight credit			
Height of window	Value	BREEAM Health and Wellbeing Credit Hea 01 Status		LEED NC 2.2 Credit IEQ 8.1	
		Criterion a) 80% of area adequately day lit	Criterion b) Uniformity ratio ≥ 0.4 , min DF = 0.8%		Final status
		1m	PASS		FAIL
1.4 m (Base case)	PASS	FAIL	FAIL	FAIL	
1.6 m	PASS	FAIL	FAIL	FAIL	
1.8 m	PASS	FAIL	FAIL	FAIL	
2 m	PASS	FAIL	FAIL	FAIL	
2.2 m	PASS	FAIL	FAIL	FAIL	

Window wall ratio	2.4 m	PASS	<i>FAIL</i>	<i>FAIL</i>	<i>FAIL</i>
	25%	PASS	<i>FAIL</i>	<i>FAIL</i>	<i>FAIL</i>
	30% (Base case)	PASS	<i>FAIL</i>	<i>FAIL</i>	<i>FAIL</i>
	35%	PASS	PASS	PASS	<i>FAIL</i>
	40%	PASS	PASS	PASS	<i>FAIL</i>
	50%	PASS	PASS	PASS	<i>FAIL</i>
The height of windowsills	0.7 m	PASS	<i>FAIL</i>	<i>FAIL</i>	<i>FAIL</i>
	0.8 m	PASS	<i>FAIL</i>	<i>FAIL</i>	<i>FAIL</i>
	0.9 m	PASS	<i>FAIL</i>	<i>FAIL</i>	<i>FAIL</i>
	1 m	PASS	<i>FAIL</i>	<i>FAIL</i>	<i>FAIL</i>
	1.1 m	PASS	<i>FAIL</i>	<i>FAIL</i>	<i>FAIL</i>
	1.2 m (Base case)	PASS	<i>FAIL</i>	<i>FAIL</i>	<i>FAIL</i>
Daylight strategies	Roof monitor	PASS	<i>FAIL</i>	<i>FAIL</i>	PASS
	Light shelf	PASS	<i>FAIL</i>	<i>FAIL</i>	<i>FAIL</i>
	Light shelf with clerestories	<i>FAIL</i>	<i>FAIL</i>	<i>FAIL</i>	<i>FAIL</i>

4. DISCUSSION

This study has benefitted from DesignBuilder as valid software in daylight simulation, which applies static metrics. Although the accuracy of the DesignBuilder radiance simulation engine has been approved by many studies such as Reinhart and Andersen [25], the results of the simulation were also validated against field measurements. Even though the MBE is in an acceptable range (0.16), the model input data (e.g. window dirt coefficient) could be refined in order to reduce the MBE.

Three different levels of minimum, maximum, and average have been simulated for all daylight metrics. It is of utmost importance to note that minimum and average limits are mostly defined in rating tools to assess daylight performance. Indeed, the maximum levels of these metrics perform as a controller and not as a credit for assessing the level of daylight. As a result, it is more important to reach higher “minimum and average levels” than higher “maximum levels”. Accordingly, window configurations which have attained higher “minimum and average levels” compared to that of the base case actually provide better daylight performance.

Results show that by increasing window-head-height and reducing the height of windowsill, intensity and uniformity decreased. On the other hand, installing a light shelf with clerestories or roof monitor, and increasing window-wall-ratio let more distributed daylight in, improving both the level of daylight and its uniformity. Generally, applying a roof monitor resulted in the best “daylight performance”, increasing daylight intensity and uniformity in the classroom.

Although light shelves provide more even daylight distribution (in full sun condition), they let less overall daylight entering especially in overcast conditions and are also expensive to construct. Furthermore, roof monitors are architecturally interesting and provide a better quality of light, but they are also expensive to construct, require a larger aperture for equivalent daylight factor, and perform less well in overcast conditions.

The models simulated for light shelves and roof

monitors in this paper are not the most optimized and their performance can be increased by applying the following strategies: selecting durable but reflective light shelf material, using horizontal blinds inside window panes, elongating the room to increase glazing, sloping the ceiling from the top of the light shelf down to the back of the room and implementing light shelves to complement the roof monitors.

Similarly, to maximize “roof monitor performance” the following strategies can be employed: using light colored roofing in front of the monitors, applying baffles to block direct sunlight and reduce glare, implementing translucent baffles to help reducing contrast at the wall-to-ceiling intersection and minimizing the depth of the ceiling cavity. These strategies could be optimized by parametric analysis, which was out of the scope of this paper.

Regarding LEED and BREEAM standards, results show that increasing window-wall-ratio to 35, 40 and 50% has reached standards of BREEAM and installing a roof monitor reaches the thresholds of the LEED credits. According to the fact that none of these windows' configurations have reached the standards required by both LEED and BREEAM credits, the authors believe that a combination of installing monitor roof and light shelves and increasing window-wall-ratio may result in enhanced daylight levels. Regarding the LEED credit, it is highly unlikely to get this LEED point without skylights [39]. In addition, since this credit runs under clear sky conditions, it should be considered as a worst case scenario rather than typical conditions at the building site. That is why despite the fact that static metrics (point in time) are more common, there has been an increasing trend toward dynamic (annual metrics) in the past few years. These metrics are location-based (they use actual weather data, similar to energy modeling tools) and are summarize performance over the entire year. Accordingly, these metrics have been replaced by dynamic ones in LEED v. 4.

Although it has been previously reported than illuminances greater than 2000 lux may cause glare and visual discomfort [26], it is impossible to incorporate project design parameters like occupancy schedules,

climate and the variability of daylight by static metrics, which are all important in daylight performance.

Two of dynamic metrics, Spatial Daylight Autonomy (sDA) and Annual Sun Exposure (ASE), together illustrate a well-defined image of daylight performance and could help architects make good design decisions, as codified in LEED v4 [40]. These metrics have great advantages over static metrics, but they have only been integrated into a few simulation soft wares (e.g. DIVA, IES) and require more development.

5. CONCLUSION

As stated earlier, daylight plays a crucial role in improving students' performance which is in turn largely affected by window configurations. This paper studies the effect of each window configuration on daylight performance. Further studies are encouraged in order to carry out simulations in which different window configurations are run simultaneously to obtain more optimum results. For instance, the south side of the classroom can be daylit by windows and light shelves while the north part of the classroom can be daylit by a roof monitor to increase uniformity and at the same time reduce glare and contrast. In addition, by placing one window on each end of the south wall, daylighting within the space may be more balanced. Future studies may evaluate suggested windows configurations by annual metrics to avoid glare, excessive sunlight, and visual discomfort and simultaneously provide enough daylight level.

To acknowledge the limits, the paper has gone through measurements and simulations to examine daylight intensity and uniformity, while field studies can take into account all physiological, psychological, and behavioral aspects of daylight to assess visual comfort and performance. Students' preferences, satisfaction and expectations can all be more precisely addressed through subjective measurements and questionnaires. It is expected that future studies compare subjective measurements with objective measurements to yield more user-friendly results. In addition, it is also recommended that dynamic metrics like spatial daylight autonomy and annual sunlight exposure be applied in studies, since they consider daylighting condition of the whole year and are usually better understood by students and users.

REFERENCES

[1] Sufar S, Talib A, Hambali H. Towards a better design: physical interior environments of public libraries in peninsular malaysia, *Procedia-Social and Behavioral Sciences*, 2012, Vol. 42, pp. 131-143.

[2] Veitch JA, Newsham GR. Determinants of lighting quality I: State of the science, *Journal of the Illuminating Engineering Society*, 1998, No. 1, Vol. 27, pp. 92-106.

[3] Baker N, Steemers K. *Daylight design of buildings: a handbook for architects and engineers*, Routledge, 2014.

[4] Rea MS, Ouellette MJ. *Relative visual performance: A basis for application*, *Lighting Research and Technology*,

1991, No. 3, Vol. 23, pp. 135-144.

[5] Kilic DK, Hasirci D. Daylighting concepts for university libraries and their influences on users' satisfaction, *The Journal of Academic Librarianship*, 2011, No. 6, Vol. 37, pp. 471-479.

[6] Othman AR, Mazli MAM. Influences of daylighting towards readers' satisfaction at Raja Tun Uda public library, Shah Alam, *Procedia-Social and Behavioral Sciences*, 2012, Vol. 68, pp. 244-257.

[7] Demir A, Konan APDN. Impact of daylighting on student and teacher performance, *Journal of Educational and Instructional Studies in the World*, 2013, p. 1.

[8] Galasiu AD, Reinhart CF. Current daylighting design practice: a survey, *Building Research & Information*, 2008, No. 2, Vol. 36, pp. 159-174.

[9] Leslie R. Capturing the daylight dividend in buildings: why and how? *Building and Environment*, 2003, No. 2, Vol. 38, pp. 381-385.

[10] Mahdavinejad M, et al. Estimation of daylight availability and illuminance on vertical south facing surfaces in Tehran, in *Advanced Materials Research*, Trans Tech Publ, 2012.

[11] Bennett S. Libraries and learning: A history of paradigm change, portal, *Libraries and the Academy*, 2009, No. 2, Vol. 9, pp. 181-197.

[12] Phillips D. *Daylighting: natural light in architecture*, Routledge, 2004.

[13] Boubekri M, Boyer LL. Effect of window size and sunlight presence on glare. *Lighting Research and Technology*, 1992, No. 2, Vol. 24, pp. 69-74.

[14] Cammarano S, et al. Assessment of daylight in rooms with different architectural features, *Building Research & Information*, 2015, No. 2, Vol. 43, pp. 222-237.

[15] Acosta I, et al. Analysis of daylight factors and energy saving allowed by windows under overcast sky conditions, *Renewable Energy*, 2015, Vol. 77, pp. 194-207.

[16] Hee W, et al. The role of window glazing on daylighting and energy saving in buildings, *Renewable and Sustainable Energy Reviews*, 2015, Vol. 42, pp. 323-343.

[17] Lee H, Seo J, Kim Y. A preliminary study on optimal variable of light shelf based on the gambrel ceiling and pyramid ceiling for the advanced daylight performance, *Advanced Science and Technology Letters*, 2014, Vol. 55, pp. 9-12.

[18] Axarli K, Tsikaloudaki K. Enhancing visual comfort in classrooms through daylight utilization, in *Congress, Wellbeing indoors*, 2007.

[19] Koti R, Architects B, Munshi M. Daylighting analysis of a classroom space using BIM geometry and next generation metrics, in *38th ASES National Solar Conference*, 2009.

[20] Athalye R, Eckerlin H, Atre U. Comparison of results from the daylighting simulation of a side-lit classroom using daysim with actual measured annual illuminances.

[21] Eckerlin HM. An evaluation of daylighting in four schools in the research triangle area of north carolina, NC Solar Center, Mechanical & Aerospace Engineering, North Carolina State University, 2005, pp. 1-19.

[22] Design I. *Guide for daylighting schools*, Guide for Daylighting Schools, 2004.

[23] Reinhart CF, Mardaljevic J, Rogers Z. Dynamic daylight performance metrics for sustainable building design, *Leukos*, 2006, No. 1, Vol. 3, pp. 7-31.

[24] Dubois MC. *Impact of Shading Devices on Daylight Quality in Offices-Simulations with Radiance*, 2001.

[25] Reinhart CF, Andersen M. Development and validation of a Radiance model for a translucent panel, *Energy and*

- [26] Buildings, 2006, No. 7, Vol. 38, pp. 890-904.
- [26] Nabil A, Mardaljevic J. Useful daylight illuminance: a new paradigm for assessing daylight in buildings, *Lighting Research and Technology*, 2005, No. 1, Vol. 37, pp. 41-57.
- [27] BNV. *New Construction – Technical Manual*, Norwegian Green Building Council and BRE Global, (SD 5066A: ISSUE 1.1), 2012, pp. 1-397.
- [28] Balocco C, Calzolari R. Natural light design for an ancient building: A case study, *Journal of Cultural Heritage*, 2008, No. 2, Vol. 9, pp. 172-178.
- [29] Escuyer S, Fontoynt M. Lighting controls: a field study of office workers' reactions, *Lighting Research and Technology*, 2001, No. 2, Vol. 33, pp. 77-94.
- [30] Scherer J. Light and libraries, *Library hi tech.*, 1999, No. 4, Vol. 17, pp. 372-358
- [31] Simm S, Coley D. The relationship between wall reflectance and daylight factor in real rooms, *Architectural Science Review*, 2011, No. 4, Vol. 54, pp. 329-334.
- [32] Cantin F, Dubois MC. Daylighting metrics based on illuminance, distribution, glare and directivity, *Lighting Research and Technology*, 2011, No. 3, Vol. 43, pp. 291-307.
- [33] Ko DH, Elnimeiri M, Clark RJ. Assessment and prediction of daylight performance in high-rise office buildings, *The Structural Design of tall and special buildings*, 2008, No. 5, Vol. 17, pp. 953-976.
- [34] Chaharmahal Weather Station Website. Retrieved from <http://www.chaharmahalmnet.ir/stat/archive/iran/esf/KAS/HAN/38.asp>.
- [35] Rungta S, Singh IV. Design guide: horizontal shading devices and light shelves. vipul singh, Assignment, 2011.
- [36] Reinhart C, Breton PF. Experimental validation of Autodesk® 3ds Max® Design 2009 and DAYSIM 3.0. *Leukos*, 2009, No. 1, Vol. 6, pp. 7-35.
- [37] Diego Ibarra CFR. Teaching daylight simulations - improving modeling workflows for simulation novices, *Proceedings of BS2013, 13th Conference of International Building Performance Simulation Association*, (Chambéry, France), 2013, pp. 1126-1135.
- [38] Merritt FS, Ricketts JT. *Building design and construction handbook*, 2001, Vol. 13, Citeseer.
- [39] Carrier K, Ubbelohde MS. The role of daylighting in leedtm certification: a comparative evaluation of documentation methods.
- [40] Rizzo G, Cannistraro GFAG. Algorithms for the calculation of the mean projected area factors of seated and standing persons. *Energy and Buildings*, 1991, Vol. 17, pp. 221-230.

AUTHOR (S) BIOSKETCHES

Zomorodian Z. S, PhD Researcher, Department of Architecture, Shahid Beheshti University, Tehran, Iran.
Email: z_zomorodian@sbu.ac.ir

Korsavi S. S, Master of Architecture, Department of Architecture, Shiraz University, Iran.
Email: sepidehkorsavi@gmail.com

Tahsildoost M, Assisntant Professor, Department of Building Construction, Shahid Beheshti University, Tehran.
Email: m_tahsildoost@sbu.ac.ir

COPYRIGHTS

Copyright for this article is retained by the author(s), with publication rights granted to the journal.
This is an open-access article distributed under the terms and conditions of the Creative Commons Attribution License (<http://creativecommons.org/licenses/by/4.0/>).

HOW TO CITE THIS ARTICLE

Zomorodian1, Z. S; Korsavi, S., Tahsildoost, M.; (2016). *The effect of window configuration on daylight performance in classrooms: A field and simulation study. Int. J. Architect. Eng. Urban Plan*, 26(1): 15-24, June 2016

URL: <http://ijaup.iust.ac.ir/article-1-254-en.html>

